

SPÖCK®

S T E M S



ERSATZTEILE | SPARE PARTS

POSITIONSLEUCHE

Unsere Positionslampen erfüllen, je nach Farbwahl der Lichtscheibe, unterschiedliche Funktionen. Ihr Design ist einheitlich und geradlinig. Ihre Montage kann direkt oder mit Halter erfolgen. Universelle Anschlüsse machen die Positionslampen zu universellen Lichtlösungen.

POSITION LAMP

Our position lamps fulfill different functions, depending on the color selection of the lens. Their design is uniform and clean. They can be mounted directly or with a bracket. Universal connections make the position lamps universal lighting solutions.

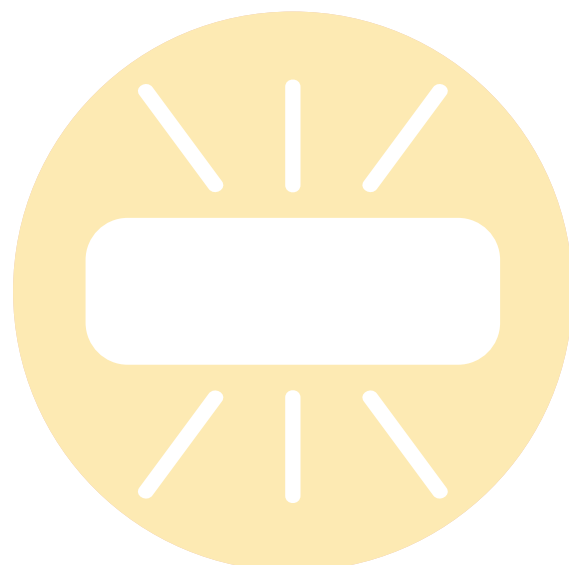



FLATPOINT II LED

ADR Zone 2 IP 69K

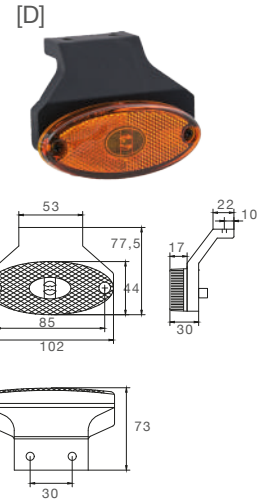
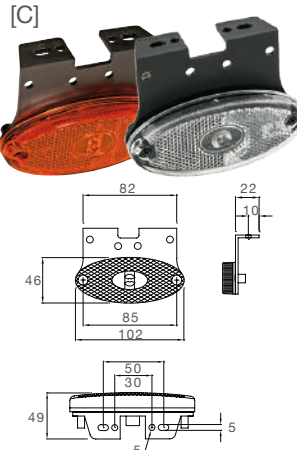
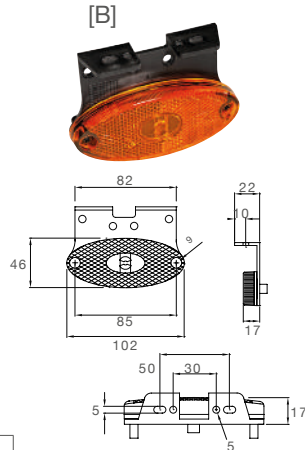
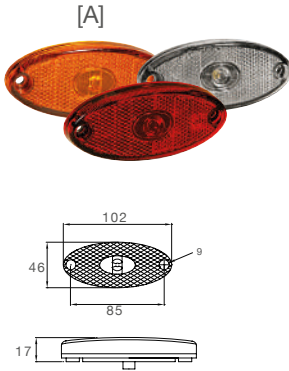

BEST. NR PART NO				ZUSATZ ADD ON		ANSCHLUSS CONNECTOR						
				[A]	Bild			P&R			0,50 m	
31-2304-014	1/-	LED	24V	[A]	Bild			P&R			0,50 m	
31-2304-034	1/50	LED	24V	[A]	Bild			P&R			1,50 m	
31-2304-044	1/50	LED	24V	[A]	Bild			P&R			2,00 m	
31-2304-094	1/50	LED	12V 24V	[A]	Bild			P&R			1,50 m	
31-2304-104	-/-	LED	12V 24V	[A]	Bild			P&R			0,50 m	
31-2307-004	1/30	LED	24V	[A]	Bild			2 pol. ASS3 2 pin ASS3	♀		0,50 m	
31-2307-014	1/50	LED	24V	[A]	Bild			2 pol. ASS3 2 pin ASS3	♀		1,50 m	
31-2364-014	1/100	LED	24V	[B]	Bild			P&R			0,50 m	
31-2364-034	1/50	LED	24V	[B]	Bild			P&R			1,50 m	
31-2364-084	1/50	LED	24V	[C]	Bild			P&R			0,50 m	
31-2364-104	1/50	LED	24V	[C]	Bild			P&R			1,50 m	
31-2364-114	1/25	LED	24V	[C]	Bild			P&R			2,00 m	
31-2364-184	1/50	LED	24V	[D]	Bild			P&R			1,50 m	
31-2364-304	1/-	LED	24V	[E]	Bild			P&R			0,25 m	



FLATPOINT II LED

ADR Zone 2 IP 69K

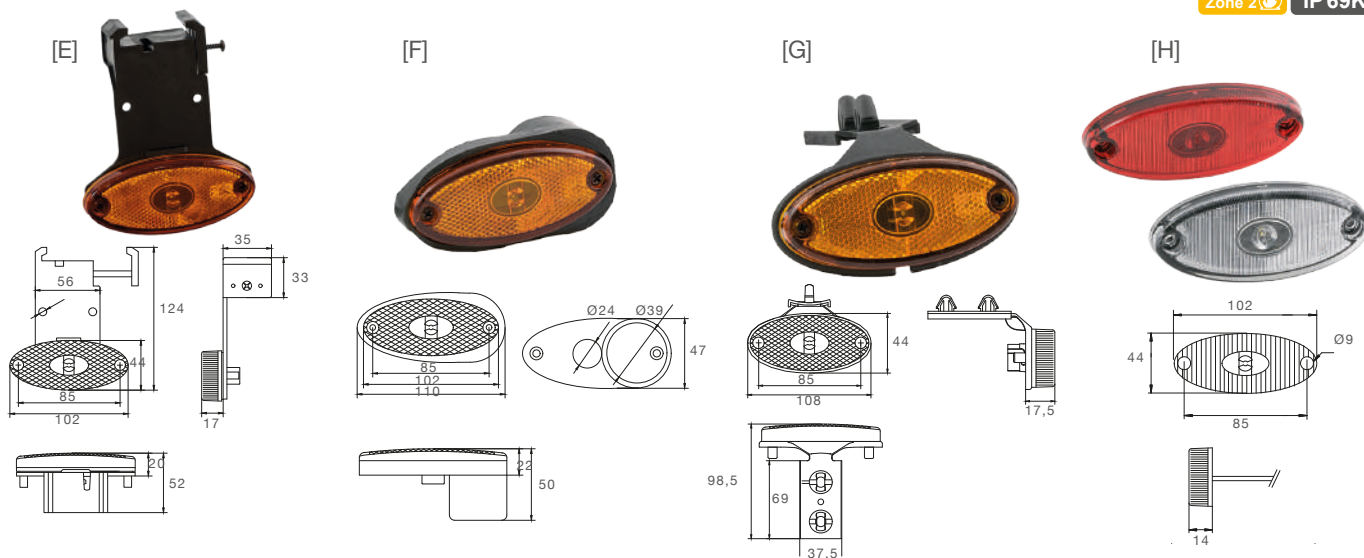

Positionslampe
Position Lamp

BEST. NR				ZUSATZ	ANSCHLUSS	
PART NO				ADD ON	CONNECTOR	
31-2364-324	1/-	LED	24V	[F] Bild	P&R	2,00 m
31-2364-334	1/-	LED	24V	[G] Bild	P&R	1,50 m
31-2364-344	1/-	LED	24V	[G] Bild	P&R	1,00 m
31-2364-354	1/50	LED	24V	[G] Bild	P&R	2,00 m
31-2367-034	1/-	LED	24V	[C] Bild	2 pol. ASS3 2 pin ASS3	1,50 m
31-2367-054	-/-	LED	24V	[B] Bild	2 pol. ASS3 2 pin ASS3	1,50 m
31-2367-064	1/50	LED	24V	[G] Bild	2 pol. ASS3 2 pin ASS3	1,50 m
31-6900-014	1/20	LED	24V	[A] Bild	offenes Ende open end	0,50 m
31-6904-014	1/100	LED	24V	[A] Bild	P&R	0,50 m
31-6904-034	1/50	LED	24V	[A] Bild	P&R	1,50 m
31-6904-054	1/50	LED	24V	[A] Bild	P&R	3,50 m
31-6904-124	1/-	LED	24V	[H] Bild	P&R	3,50 m
31-6904-164	-/-	LED	12V 24V	[A] Bild	P&R	1,50 m
31-6907-034	-/-	LED	24V	[A] Bild	2 pol. ASS3 2 pin ASS3	1,50 m
31-6964-004	-/-	LED	24V	[C] Bild	P&R	1,50 m
31-6404-014	1/50	LED	24V	[A] Bild	P&R	0,50 m
31-6404-094	1/-	LED	24V	[H] Bild	P&R	0,50 m
31-6404-124	1/50	LED	24V	[H] Bild	P&R	3,50 m



FLATPOINT II LED

ZUBEHÖR / ACCESSORIES

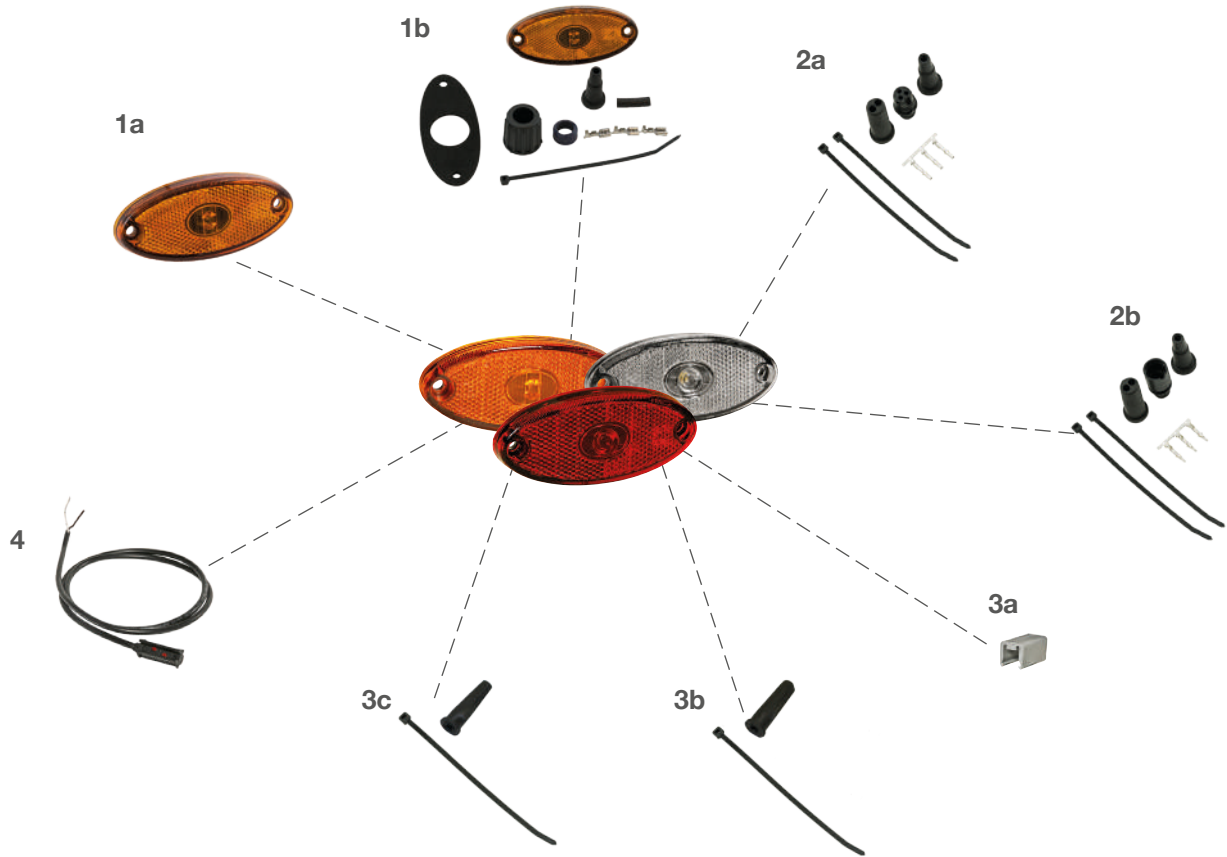

1 Ersatzleuchte orange | spare part lamp orange

- (a) lose
loose..... 21-2303-004
- (b) mit Bajonett- Mutter
with bayonet-nut 21-2302-004

2 ASS3 Verbinder | ASS3 connector

- (a) 3 pol. weiblich
3 pin female 13-0322-281
- (b) 3 pol. männlich
3 pin male 13-0332-281

3 für P&R Verbinder | for P&R connector

- (a) Verschlusskappen
caps..... 15-5971-014
- (b) Endkappen rund
end caps round..... 15-5983-024
- (c) Endkappen eckig
end caps square..... 15-5729-014

4 Anschlusskabel P&R | connection cable P&R

- 0,5 m..... 68-5000-014
- 1,5 m..... 68-5000-034







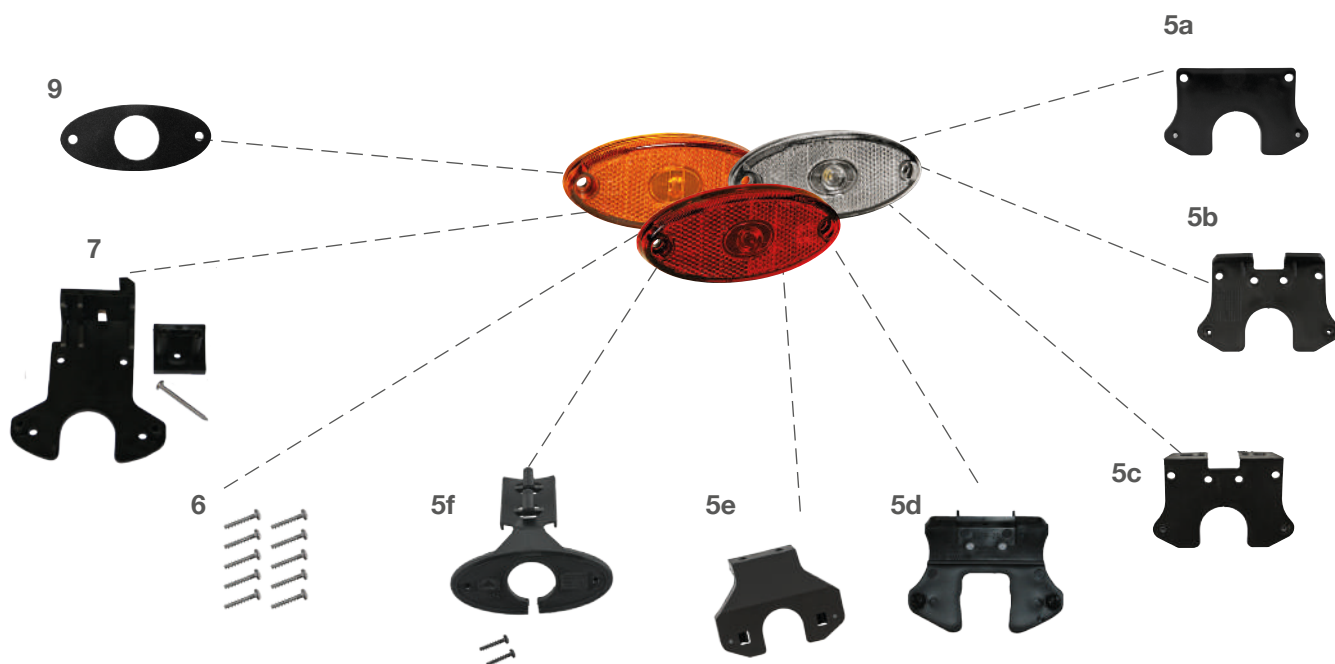

FLATPOINT II LED

ZUBEHÖR / ACCESSORIES



5 Haltewinkel | bracket

- (a) gerade
straight 15-5321-004
- (b) 90° nach vorne
90° to the front..... 15-5321-104 
- (c) 90° nach hinten
90° to the back..... 15-5321-204 
- (d) 90° durchgehend nach hinten
90° continuous to the back
..... 15-5321-404
- (e) schräg 90° nach hinten
sloping 90° to the back
..... 15-2128-214 
- (f) Schnellhalter + Schrauben
quick-fixation bracket + screws
..... 15-5321-234 

6 Schrauben für Haltewinkel 10 screws for bracket

- 14-0418-304 

7 Verriegelungswinkel | locking bracket

- Verriegelungswinkel
locking angle
..... 15-5322-004 

9 Gummiunterlage | rubber base

- 15-5111-004 





FLATPOINT I LED

ADR Zone 2 IP 68

[A]

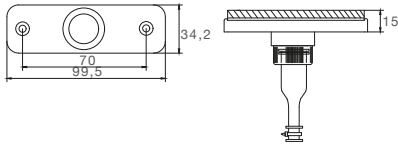

[B]

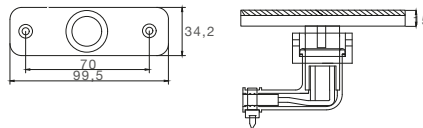

[C]

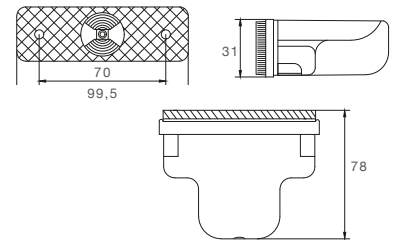

BEST. NR				ZUSATZ					ANSCHLUSS			
PART NO				ADD ON					CONNECTOR			
31-6604-014	1/50	LED	24V	[A] Bild				P&R			0,50 m	
31-6604-034	1/-	LED	24V	[A]				P&R			1,50 m	
31-6604-074	1/50	LED	24V	[B] Bild				P&R			0,50 m	
31-6604-094	1/-	LED	24V	[B]				P&R			1,50 m	
31-6604-114	-/-	LED	24V	[B]				P&R			3,50 m	
31-6607-004	1/50	LED	24V	[B] Bild				2 pol. ASS2 2 pin ASS2			1,50 m	
31-6607-054	1/75	LED	24V	[A] Bild				2 pol. ASS3 2 pin ASS3			1,50 m	
31-6614-014	1/50	LED	24V	[C] Bild				Schutzhaube protection cap	P&R		0,50 m	
31-6614-034	1/50	LED	24V	[C]				Schutzhaube protection cap	P&R		1,50 m	
31-6614-074	1/50	LED	24V	[D] Bild				Schutzhaube protection cap	P&R		0,50 m	
31-6614-094	1/40	LED	24V	[D]				Schutzhaube protection cap	P&R		1,50 m	
31-6664-014	1/-	LED	24V	[E] Bild				Schutzhaube protection cap	P&R		0,50 m	
31-6664-031	1/30	LED	24V	[E]				Schutzhaube protection cap	P&R		1,50 m	
31-6667-014	-/-	LED	24V	[D] Bild				Schutzhaube protection cap	2 pol. ASS3 2 pin ASS3		0,50 m	



FLATPOINT I LED

ADR Zone 2

IP 68

[D]

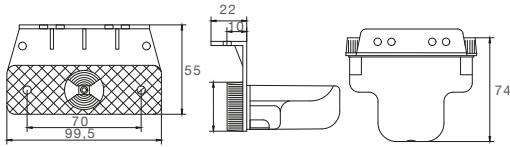

[E]

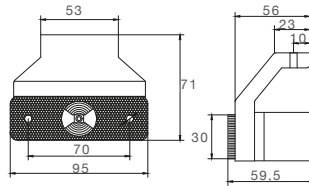

[F]

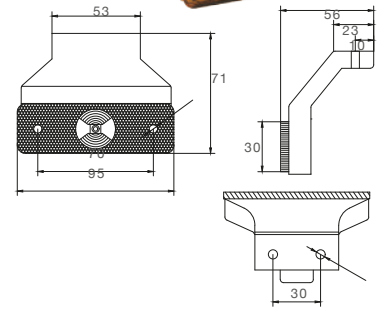

Seitenmarkierungslicht
Sidemarker light

BEST. NR PART NO				ZUSATZ ADD ON	ANSCHLUSS CONNECTOR
31-2204-014	1/50	LED	24V	[A] Bild	P&R 0,50 m
31-2214-004	1/50	LED	24V	[D] Bild Schutzhaube protection cap	P&R 0,25 m
31-2214-014	1/-	LED	24V	[D] Schutzhaube protection cap	P&R 0,50 m
31-2214-024	1/50	LED	24V	[D] Schutzhaube protection cap	P&R 1,00 m
31-2214-034	1/50	LED	24V	[D] Schutzhaube protection cap	P&R 1,50 m
31-2214-114	1/50	LED	24V	[C] Schutzhaube protection cap	P&R 0,50 m
31-2214-134	1/25	LED	24V	[C] Schutzhaube protection cap	P&R 1,50 m
31-2264-014	1/-	LED	24V	[F] Bild	P&R 0,50 m
31-2264-024	1/50	LED	24V	[F]	P&R 1,00 m
31-2264-034	1/-	LED	24V	[F]	P&R 1,50 m
31-2267-014	1/-	LED	24V	[E] Bild Schutzhaube protection cap	2 pol. ASS2 ♀ 1,00 m
31-2267-064	1/70	LED	24V	[C] Bild Schutzhaube protection cap	3 pol. ASS3 ♀ 1,50 m
31-2267-074	1/50	LED	24V	[D] Bild Schutzhaube protection cap	3 pol. ASS3 ♀ 1,50 m
31-2267-084	1/50	LED	24V	[E] Bild Schutzhaube protection cap	3 pol. ASS3 ♀ 1,50 m





FLATPOINT I LED

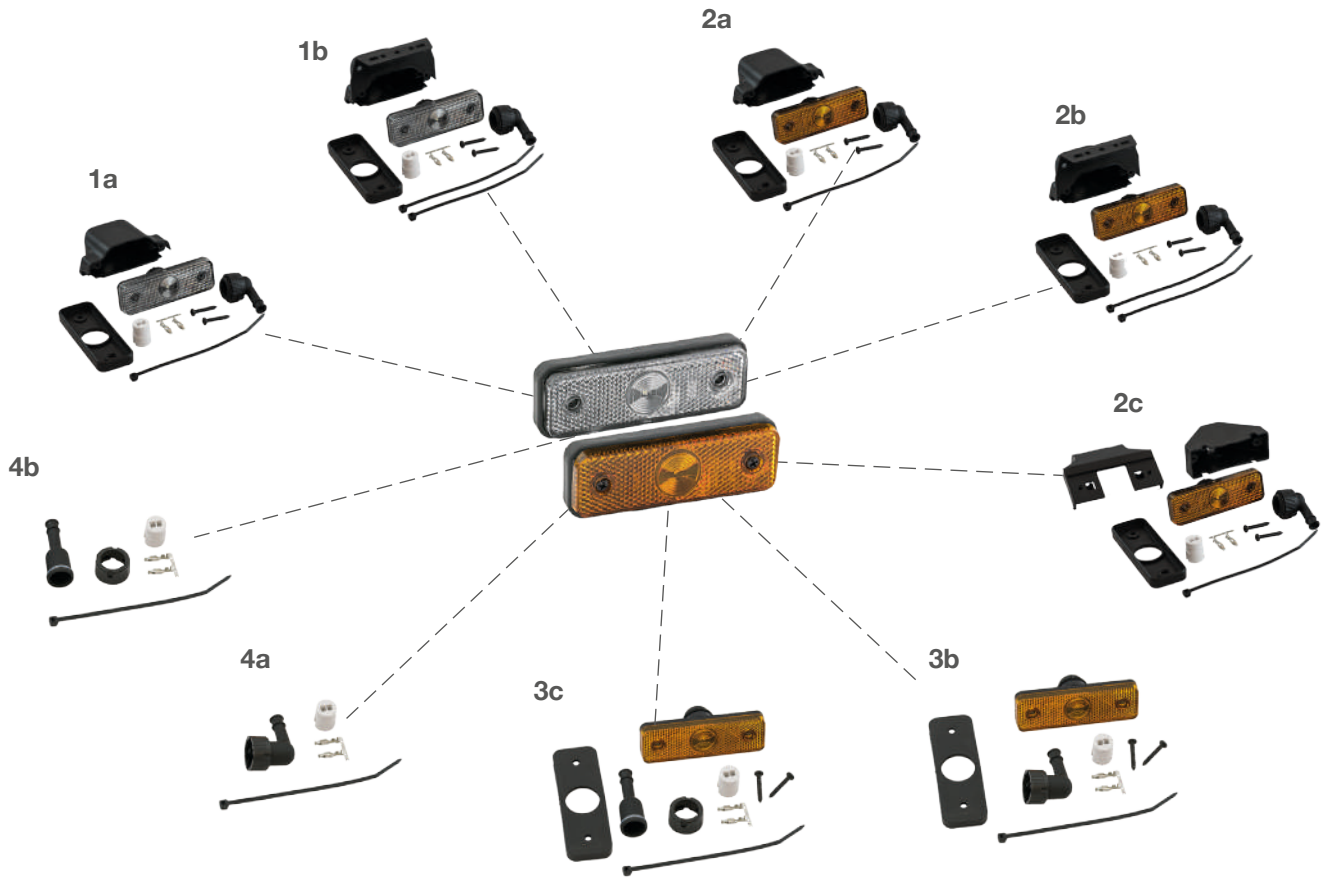

1 Ersatzleuchte weiß mit Schutzhaube | spare part lamp white with protection cap

(a) mit 90° Anschluss ohne Haltewinkel
with 90° connector without bracket

..... 21-6601-004

(b) mit 90° Anschluss und 90° Haltewinkel
with 90° connector and 90° bracket

..... 21-6600-004

2 Ersatzleuchte orange mit Schutzhaube | spare part lamp orange with protection cap

(a) mit 90° Anschluss ohne Haltewinkel
with 90° connector without bracket

..... 21-2201-004

(b) mit 90° Anschluss und 90° Haltewinkel
with 90° connector and 90° bracket

..... 21-2200-014

(c) mit 90° Anschluss und 90° Haltewinkel schräg
with 90° connector and sloping 90° bracket

..... 21-2202-004

3 Ersatzleuchte orange ohne Schutzhaube | spare part lamp orange without protection cap

(a) mit 90° Anschluss
with 90° connector

..... 21-2201-014

(b) mit geradem Anschluss
with straight connector

..... 21-2201-044

4 Anschluss | connector

(a) 90° gewinkelt
angled connection 90°

..... 15-2122-104

(b) gerade komplett
straight bracket complete

..... 15-2122-124

5 ASS1 & ASS2 Verbinder | ASS1 & ASS2 connector

(a) 2 pol. männlich

2 pin male 13-5625-991

(b) 2 pol. weiblich

2 pin female 13-5626-401

6 ASS3 Verbinder | ASS3 connector

(a) 3 pol. weiblich

3 pin female 13-0322-281

(b) 3 pol. männlich



FLATPOINT | LED

ZUBEHÖR / ACCESSORIES

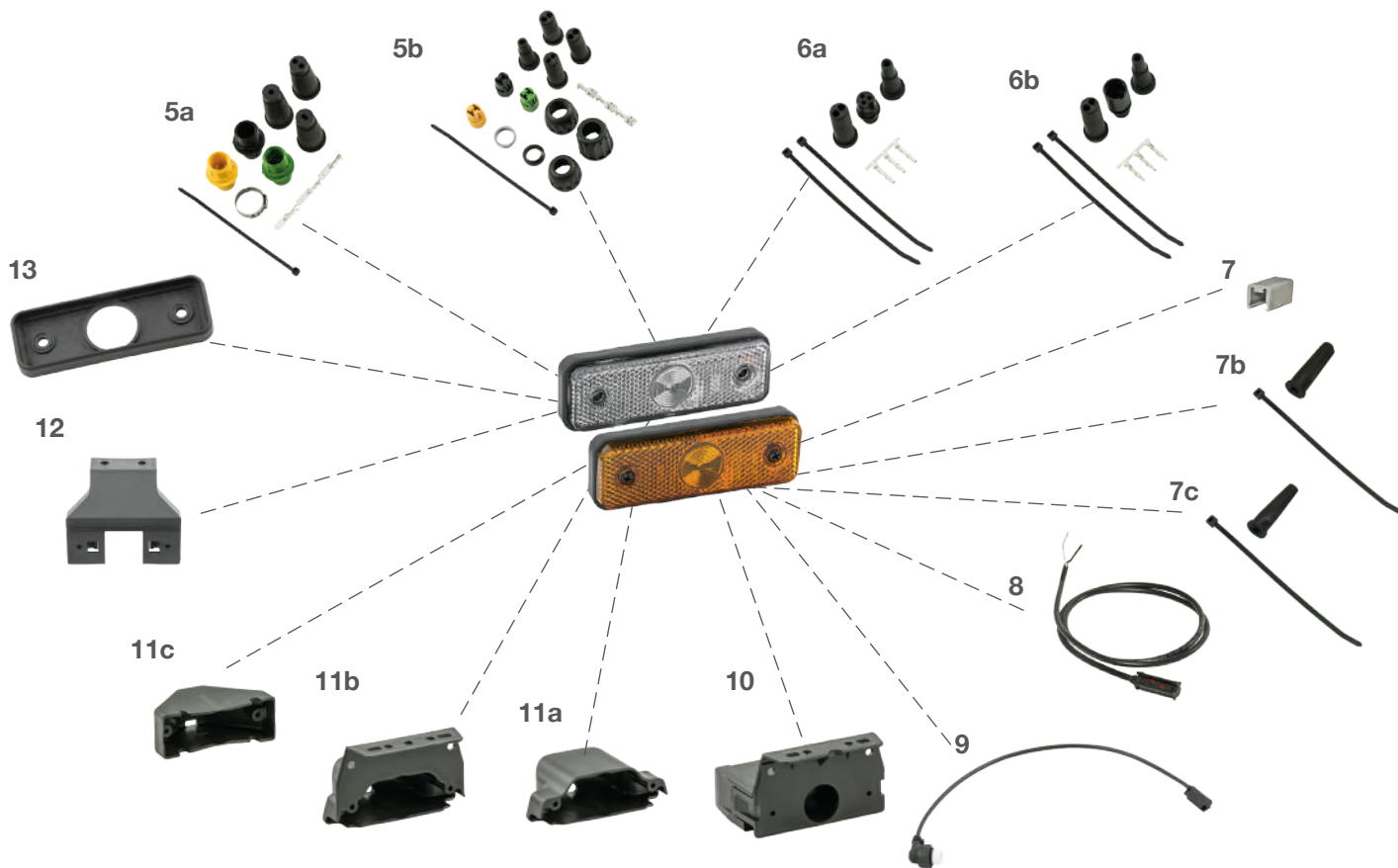



3 pin male 13-0332-281 

7 für P&R Verbinder | for P&R connector

- (a) Verschlusskappen
caps 15-5971-014 
- (b) Endkappen rund
end caps round 15-5983-024 
- (c) Endkappen eckig
end caps square 15-5729-014 

8 Anschlusskabel P&R | connection cable P&R

0,50 m 68-5000-014 

1,50 m 68-5000-034 



9 Zuleitung P&R | front connection P&R

0,50 m 31-2204-154

10 Sockel mit Haltewinkel und Schutzhaube | socket with bracket and protection cap

..... 15-2128-274 

11 Schutzhaube | protection cap

- (a) ohne Haltewinkel
without bracket 15-2122-164 
- (b) mit 90° Haltewinkel
with 90° bracket 15-2122-174 
- (c) für schrägen Haltewinkel
for sloping bracket 15-2128-094 

12 Haltewinkel | bracket

schräg
sloping 15-2128-144 

13 Gummiunterlage | rubber base

..... 11-2128-194 



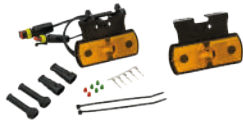

UNIPOINT II LED

ADR Zone 2 IP 6K9K



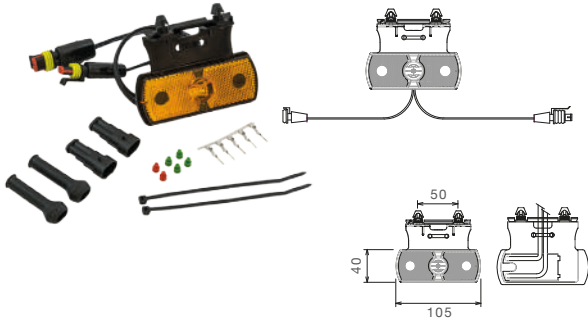



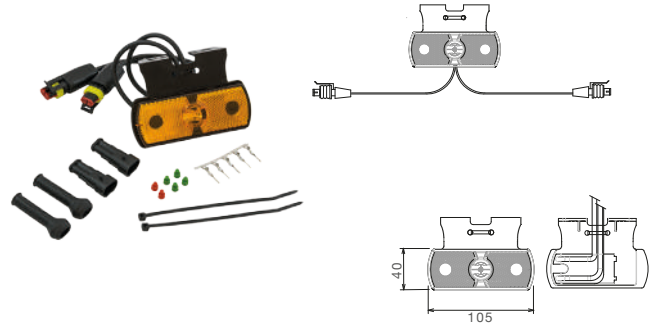







[A]



[B]



 Seitenmarkierungslicht
Sidemarker light

BEST. NR				ZUSATZ	ANSCHLUSS
PART NO		LED	24V	ADD ON	CONNECTOR
31-2464-024	1/60	LED	24V	[A]   	2 x 2 pol. Superseal 2 x 2 pin Superseal ♀   0,40 m 
31-2464-034	1/60	LED	24V	[B]   	2 x 2 pol. Superseal 2 x 2 pin Superseal ♀   0,40 m 









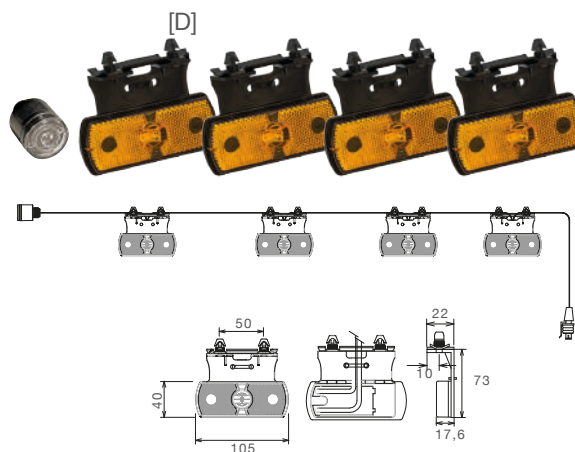
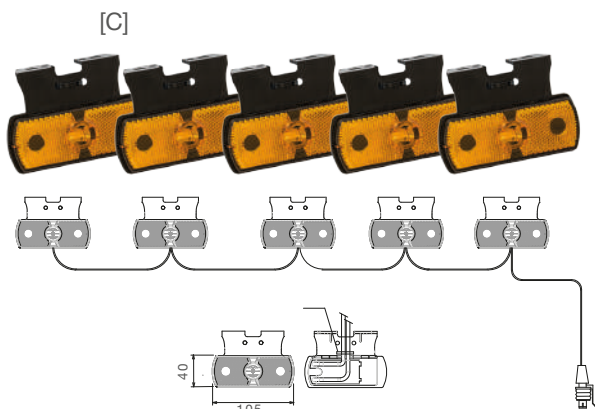







UNIPOINT II LED

ZUBEHÖR / ACCESSORIES

ADR Zone 2 IP 6K9K



 Seitenmarkierungslicht
Sidemarker light

BEST. NR PART NO				ZUSATZ ADD ON	ANSCHLUSS CONNECTOR
87-1368-011	1/-	LED	24V	[C]   	2 pol. Superseal 2 pin Superseal   2,20 m 
87-1366-011	1/8	LED	24V	[D]   	2 pol. Superseal 2 pin Superseal   6,04 m 

ZUBEHÖR / ACCESSORIES

1 Superseal Verbinder | Superseal connector

- (a) 2 pol. weiblich
2 pin female 15-7002-044 
- (b) 2 pol. männlich
2 pin male 15-7002-054 

1a



1b





UNIPOINT I LED

ADR Zone 2 IP 6K9K

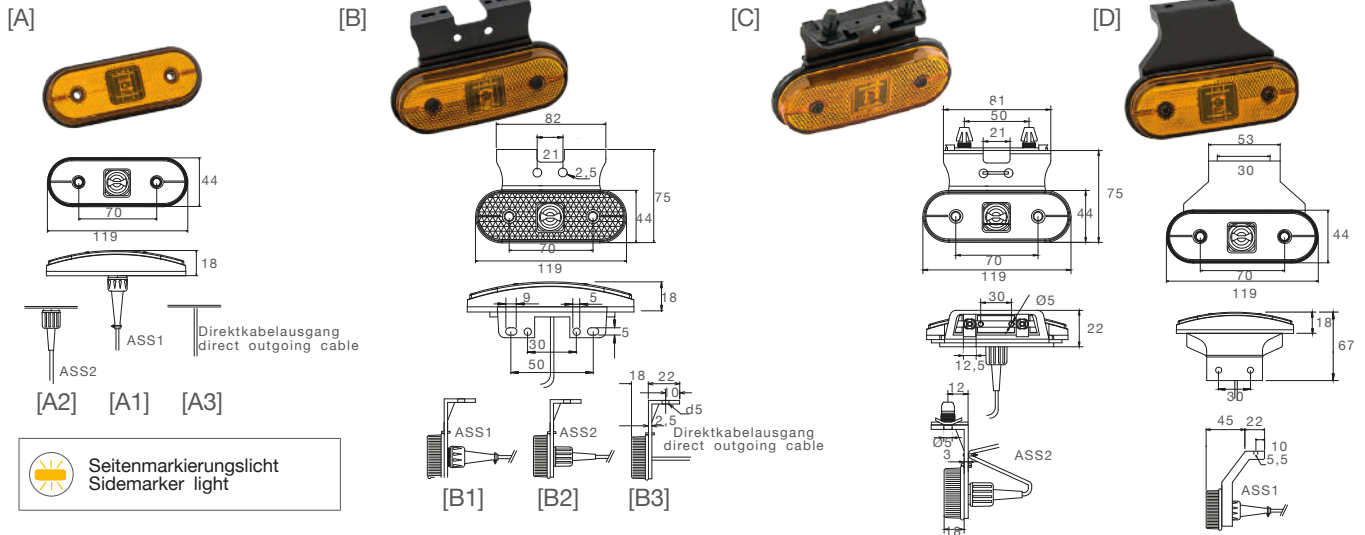

BEST. NR				ZUSATZ	ANSCHLUSS
PART NO				ADD ON	CONNECTOR
31-2000-014	-/-	LED	24V	[A3]	offenes Ende open end 0,50 m
31-2000-034	-/-	LED	24V	[A3]	offenes Ende open end 1,50 m
31-2004-014	1/100	LED	24V	[A1]	P&R 0,50 m
31-2004-034	1/50	LED	24V	[A1]	P&R 1,50 m
31-2004-044	1/-	LED	24V	[A1]	P&R 2,00 m
31-2004-074	1/50	LED	24V	[A1]	P&R 2,50 m
31-2007-024	-/-	LED	24V	[A2]	2 pol. ASS2 2 pin ASS2 ♀ 1,00 m
31-2007-234	1/-	LED	24V	[A2]	3 pol. ASS3 3 pin ASS3 ♀ 0,50 m
31-2007-244	1/25	LED	24V	[A2]	3 pol. ASS3 3 pin ASS3 ♀ 1,50 m
31-2007-294	1/-	LED	24V	[A2]	2 pol. ASS2 2 pin ASS2 ♀ 2,00 m
31-2007-304	1/-	LED	24V	[A3]	3 pol. ASS3 3 pin ASS3 ♀ 0,50 m
31-2007-334	1/-	LED	24V	[A3]	3 pol. ASS3 3 pin ASS3 ♀ 1,50 m
31-2007-344	1/100	LED	24V	[A3]	2 pol. ASS2 2 pin ASS2 ♀ 0,50 m
31-2064-014	1/90	LED	24V	[B1]	P&R 0,50 m
31-2064-034	1/75	LED	24V	[B1]	P&R 1,50 m
31-2064-124	1/-	LED	24V	[C]	P&R 2,00 m
31-2064-214	1/50	LED	24V	[D]	P&R 0,50 m



UNIPPOINT I LED

ADR Zone 2 IP 6K9K

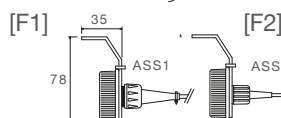
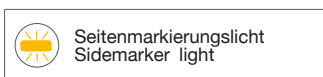
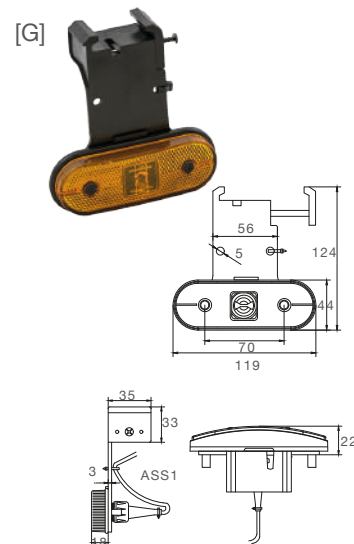
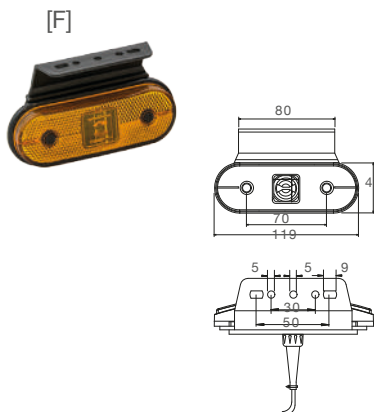
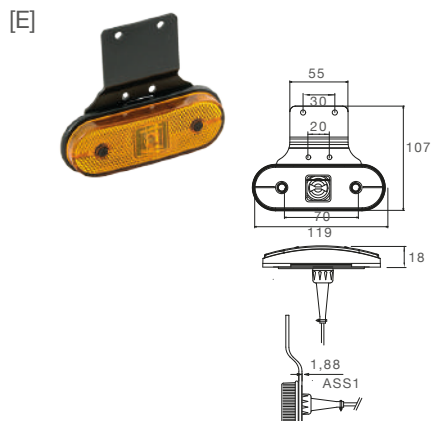

BEST. NR				ZUSATZ	ANSCHLUSS			
PART NO				ADD ON	CONNECTOR			
31-2064-234	1/35	LED	24V	[D]	P&R		1,50 m	
31-2064-414	1/50	LED	24V	[E]	P&R		0,50 m	
31-2064-434	1/-	LED	24V	[E]	P&R		1,50 m	
31-2064-714	1/45	LED	24V	[F1]	P&R		0,50 m	
31-2064-734	1/75	LED	24V	[F1]	P&R		1,50 m	
31-2064-774	1/-	LED	24V	[G]	P&R		1,00 m	
31-2067-084	-/-	LED	24V	[B2]	2 pol. ASS2 2 pin ASS2		1,50 m	
31-2067-094	1/50	LED	24V	[B2]	3 pol. ASS3 3 pin ASS3		0,50 m	
31-2067-104	1/50	LED	24V	[B2]	3 pol. ASS3 3 pin ASS3		1,50 m	
31-2067-694	1/50	LED	24V	[F2]	3 pol. ASS3 3 pin ASS3		1,50 m	
31-2104-014	1/100	LED	24V	[A3]	P&R		0,50 m	
31-2104-034	1/-	LED	24V	[A3]	P&R		1,50 m	
31-2164-014	1/100	LED	24V	[B3]	P&R		0,50 m	
31-2164-034	-/-	LED	24V	[B3]	P&R		1,50 m	



UNIPOINT I LED

ADR Zone 2 IP 6K9K

[H]

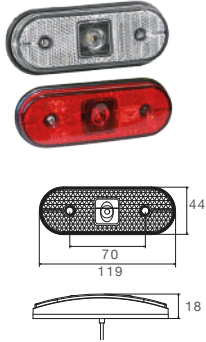

[I]

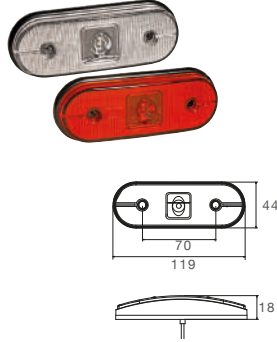

[J]

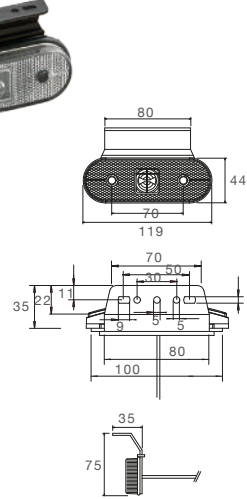

[K]

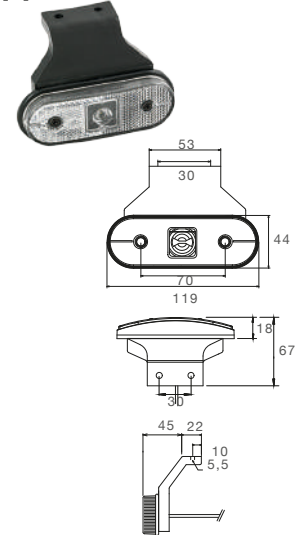

Positionslicht
Position light

BEST. NR				ZUSATZ			ANSCHLUSS
PART NO				ADD ON			CONNECTOR
31-7704-014	1/-	LED	24V	[H]			P&R 0,50 m
31-7704-034	1/40	LED	24V	[H]			P&R 1,50 m
31-7704-054	1/50	LED	24V	[H]			P&R 3,50 m
31-7704-094	1/-	LED	24V	[I]			P&R 0,50 m
31-7704-124	1/25	LED	24V	[I]			P&R 3,50 m
31-7707-034	1/-	LED	24V	[H]			2 pol. ASS2 2 pin ASS2 1,50 m
31-7707-104	1/-	LED	24V	[H]			2 pol. ASS3 2 pin ASS3 0,50 m
31-7707-114	1/-	LED	24V	[H]			2 pol. ASS3 2 pin ASS3 1,50 m
31-7707-214	-/-	LED	24V	[H]			2 pol. ASS2 2 pin ASS2 0,50 m
31-7764-014	1/-	LED	24V	[J]			P&R 0,50 m
31-7764-214	-/-	LED	24V	[K]			P&R 0,50 m
31-7764-234	1/50	LED	24V	[K]			P&R 1,50 m
31-7804-014	1/100	LED	24V	[H]			P&R 0,50 m
31-7804-054	1/-	LED	24V	[H]			P&R 3,50 m
31-7804-094	1/-	LED	24V	[I]			P&R 0,50 m
31-7804-124	1/25	LED	24V	[I]			P&R 3,50 m
31-7804-144	1/-	LED	24V	[H]			P&R 5,00 m



UNIPOINT I LED

ZUBEHÖR / ACCESSORIES

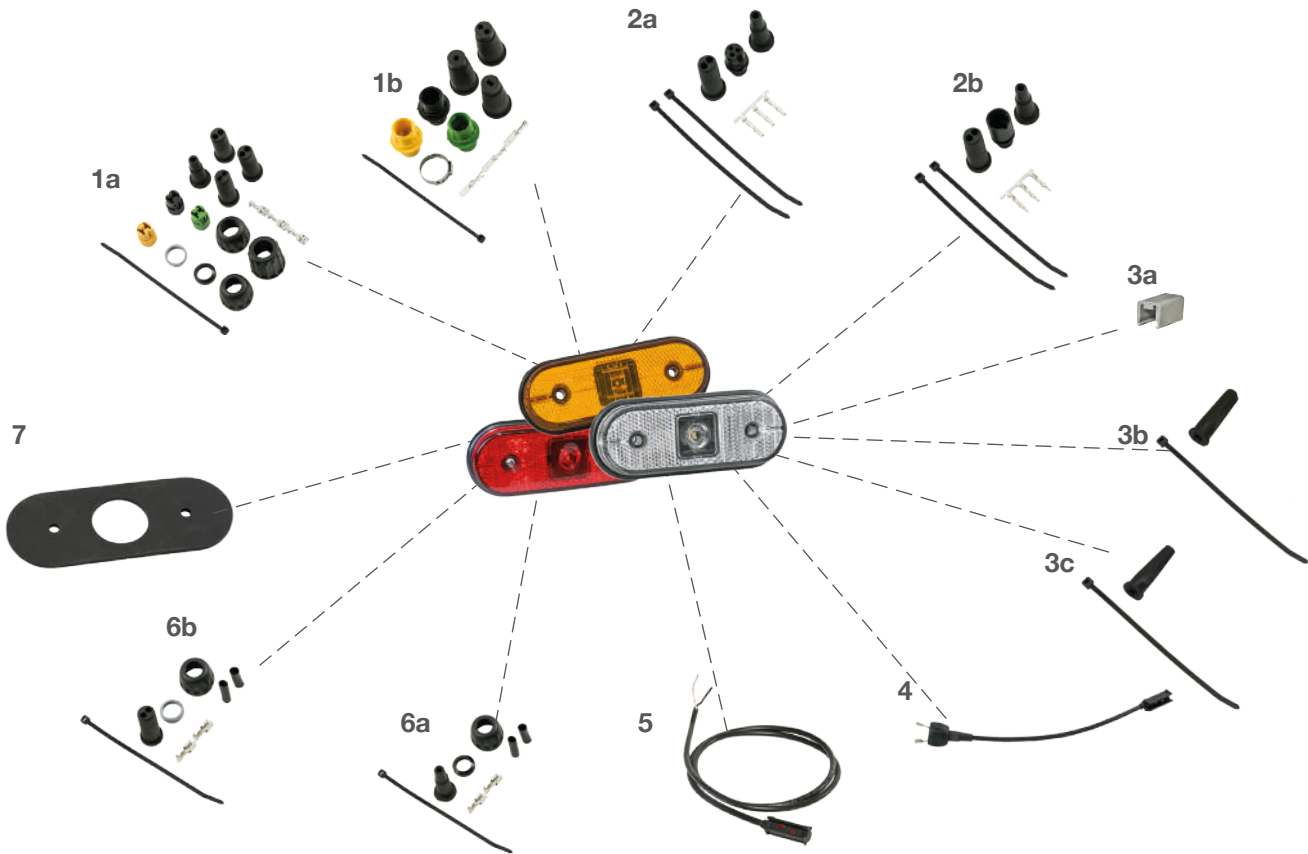

1 ASS1 & ASS2 Verbinder | ASS1 & ASS2 connector

- (a) 2 pol. weiblich
2 pin female 13-5626-401
- (b) 2 pol. männlich
2 pin male 13-5625-991

2 ASS3 Verbinder | ASS3 connector

- (a) 3 pol. weiblich
3 pin female 13-0322-281
- (b) 3 pol. männlich
3 pin male 13-0332-281

3 für P&R Verbinder | for P&R connector

- (a) Verschlusskappen
caps 15-5971-014
- (b) Endkappen rund
end caps round 15-5983-024
- (c) Endkappen eckig
end caps square 15-5729-014

4 Zuleitung mit P&R Verbinder | front connection with P&R connector

- 0,25 m 68-5018-004
- 1,5 m 68-5018-024

5 Anschlusskabel P&R | connection cable P&R

- 0,5 m 68-5000-014
- 1,5 m 68-5000-034

6 Anschluss | connector

- (a) Einfachtülle (lose)
single grommet (loose) 15-5624-014
- (b) Doppeltülle (lose)
double grommet (loose) 15-5624-024

7 Gummiunterlage | rubber base

- 15-5319-904





UNIPOINT | LED

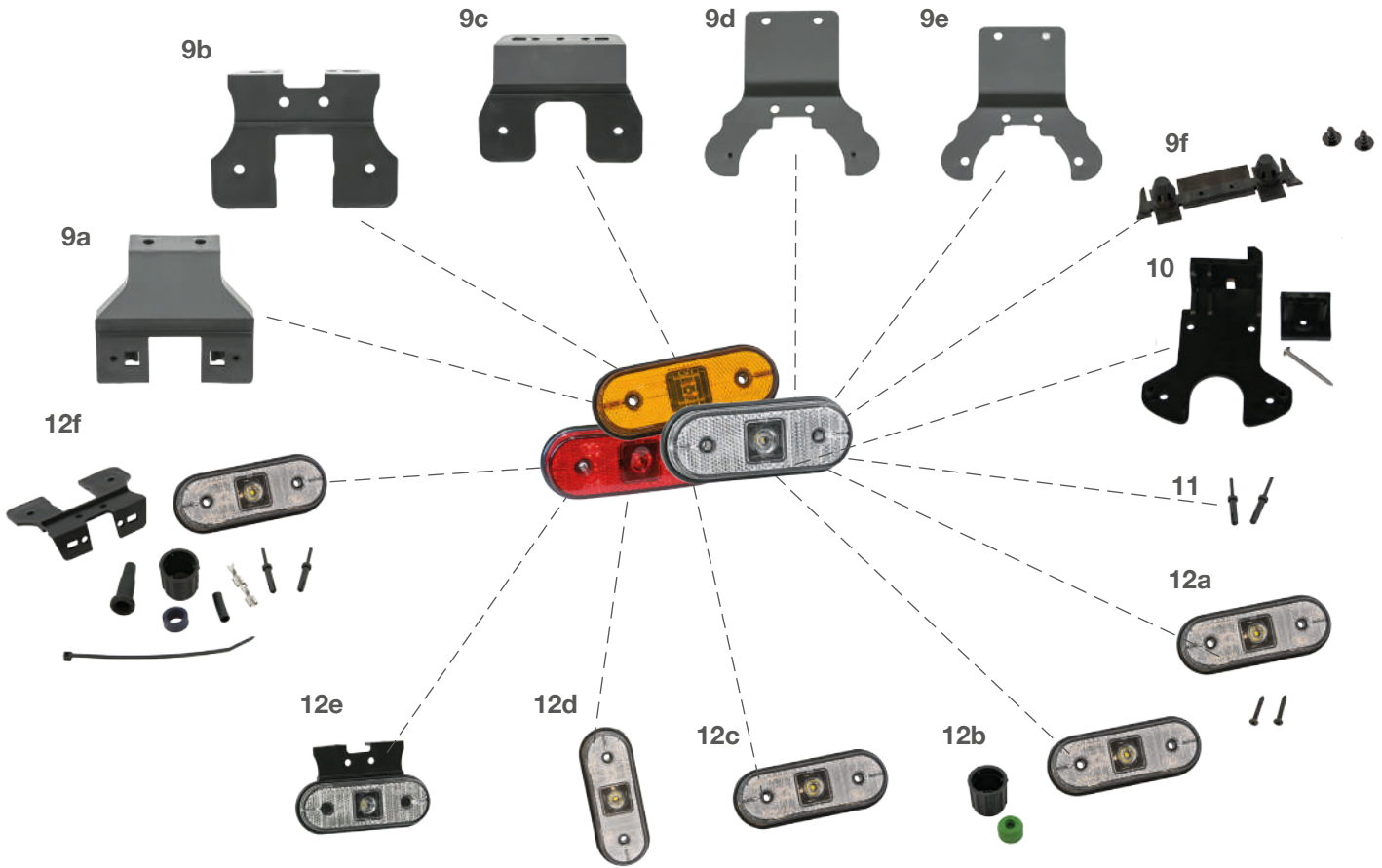

9 Haltewinkel | bracket

- (a) schräg nach hinten
sloping angle to the back
..... 15-5317-014
- (b) 90° nach hinten
90° to the back
..... 15-5319-004
- (c) schräg nach vorne
sloping to the front
..... 15-5319-304
- (d) Aufhängeteil gekröpft (Anbau mit Schrauben)
crumped bracket (screw mounting)
..... 15-5317-004
- (e) Aufhängeteil gekröpft (Anbau mit Nieten)
crumped bracket (expanding rivet-mounting)
..... 15-5317-024
- (f) Schnellhalter for SML
quick fixation bracket for SML
..... 15-2128-285

10 Verriegelungswinkel | locking bracket

- Verriegelungswinkel
locking angle
..... 15-5322-004

11 Spreizniete | expanding rivet

- 14-15 mm 14-4596-004

12 Ersatzleuchte weiß ohne Schutzhaube | spare part lamp white without protection cap

- (a) mit Schrauben
with screws 21-7700-004
- (b) geschlossen mit Bajonett-Mutter
closed by bayonet-nut
..... 21-7700-014
- (c) Standard Version
standard version 21-7700-054
- (d) vertikal
vertical 21-7702-014
- (e) mit 90° Haltewinkel nach hinten
with 90° bracket to the back
..... 21-7700-024
- (f) mit 90° Haltewinkel nach hinten
(komplett)
with 90° bracket to the back
(complete)
..... 21-7700-035



UNIPOINT | LED

ZUBEHÖR / ACCESSORIES

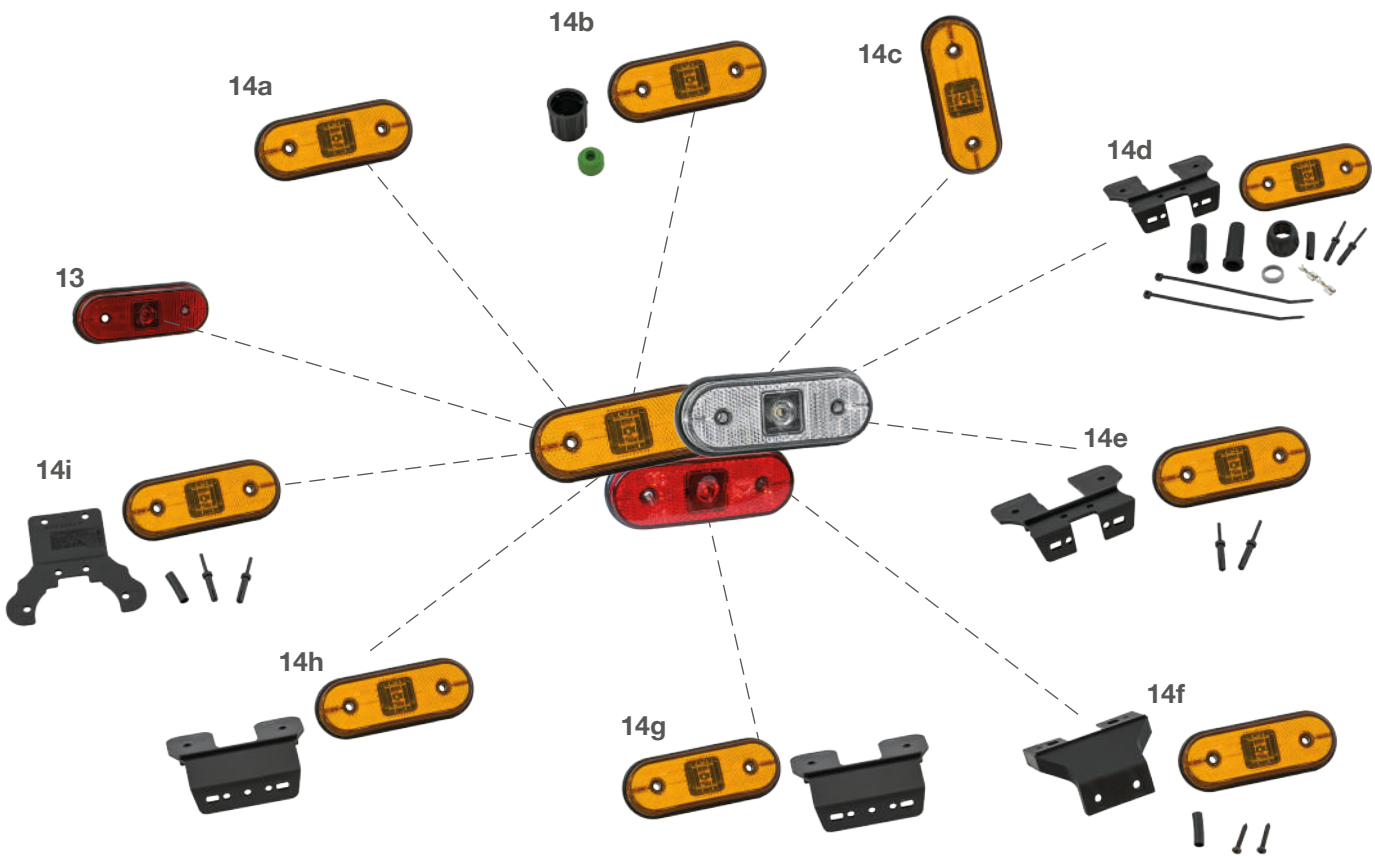

13 Ersatzleuchte rot ohne Schutzhaube |
spare part lamp red without protection cap
mit Schrauben
with screws 21-7800-004

14 Ersatzleuchte orange ohne Schutzhaube |
spare part lamp orange without protection cap

(a) ohne Schrauben
without screws..... 21-2000-154

(b) geschlossen mit Bajonett-Mutter
closed by bayonet-nut
..... 21-2000-144

(c) vertikal
vertical..... 21-2002-004

(d) mit geradem Anschluss für SML mit
90° Haltewinkel
with straight connector for SML with
90° bracket
..... 21-2000-035

(e) lose mit 90° Haltewinkel
loose with 90° bracket

..... 21-2000-014

(f) lose mit schrägem Haltewinkel
loose with sloping bracket
..... 21-2000-024

(g) mit flexiblen Haltewinkel
with flexible bracket
..... 21-2000-054

(h) mit flexiblen Haltewinkel und
Schnellhalter
with flexible bracket and quick-fixation bracket
..... 21-2000-104

(i) mit Aufhängeteil
with bracket..... 21-2000-064



UNIPPOINT DI

ADR Zone 2 IP 6K9K



Produktinformation
Product information

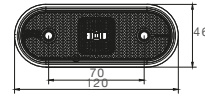

Seitenmarkierungslicht
Sidemarker light

BEST. NR				ZUSATZ	ANSCHLUSS
PART NO				ADD ON	CONNECTOR
31-2100-134	1/-	LED	24V		offenes Ende open end 1,50 m
31-2104-074	1/-	LED	24V		P&R 1,50 m
31-2107-004	1/-	LED	24V		2 pol. ASS3 2 pin ASS3 1,50 m



UNIPOINT DI

ZUBEHÖR / ACCESSORIES

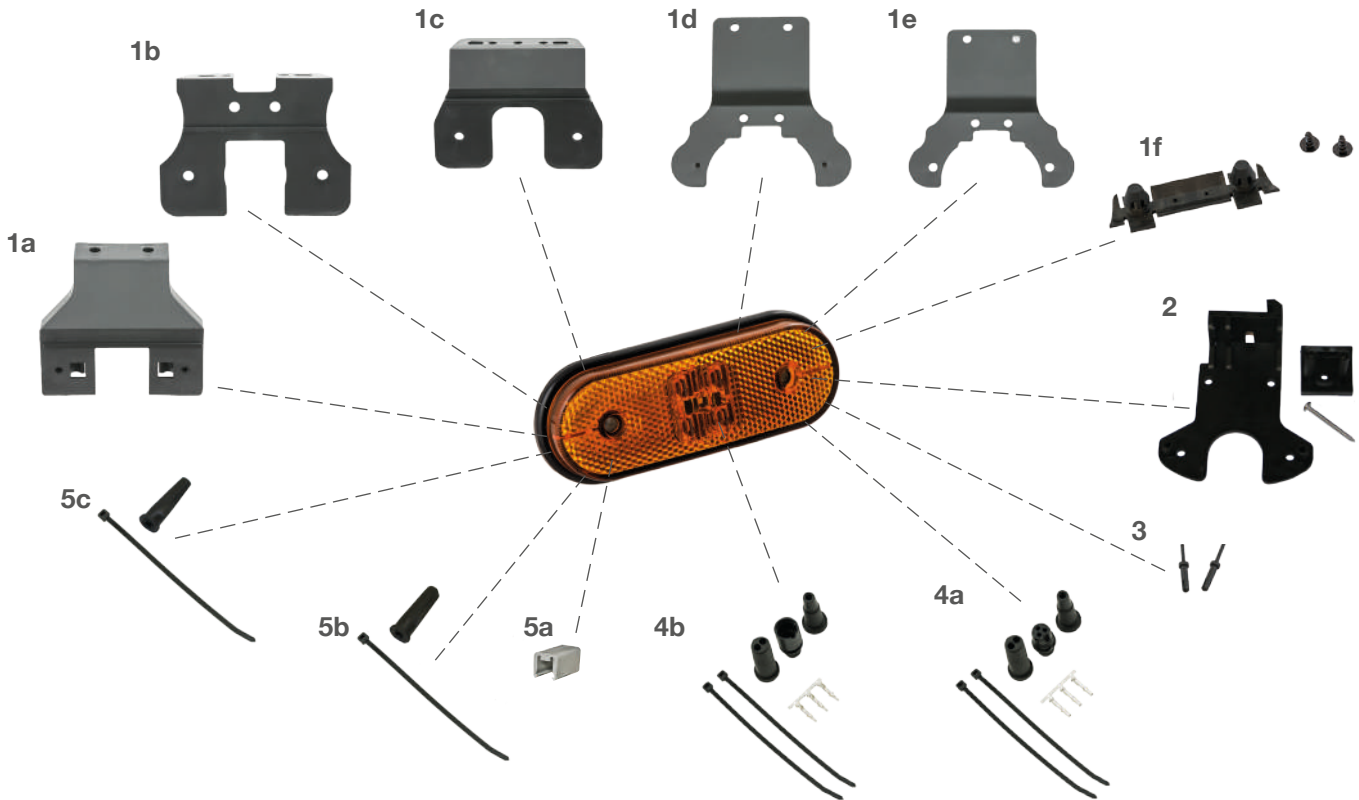

1 Haltewinkel | bracket

- (a) schräg nach hinten
sloping angle to the back
..... 15-5317-014
- (b) 90° nach hinten
90° to the back
..... 15-5319-004
- (c) schräg nach vorne
sloping to the front
..... 15-5319-304
- (d) Aufhängeteil gekröpft (Anbau mit Schrauben)
crumped bracket (screw mounting)
..... 15-5317-004
- (e) Aufhängeteil gekröpft (Anbau mit Nieten)
crumped bracket (expanding rivet-mounting)
..... 15-5317-024
- (f) Schnellhalter for SML
quick fixation bracket for SML
..... 15-2128-285

2 Verriegelungswinkel | locking bracket

- Verriegelungswinkel
locking angle
..... 15-5322-004

3 Spreizniete | expanding rivet

- 14-15 mm 14-4596-004

4 ASS3 Verbinder | ASS3 connector

- (a) 3 pol. weiblich
3 pin female 13-0322-281
- (b) 3 pol. männlich
3 pin male 13-0332-281

5 für P&R Verbinder | for P&R connector

- (a) Verschlusskappen
caps 15-5971-014
- (b) Endkappen rund
end caps round 15-5983-024
- (c) Endkappen eckig
end caps square 15-5729-014





UNIPOINT DI + SML

ADR Zone 2 IP 6K9K

[A]

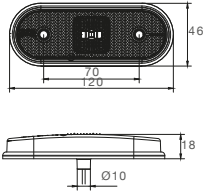

Seitenmarkierungslicht
Sidemarker light

[B]

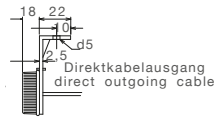
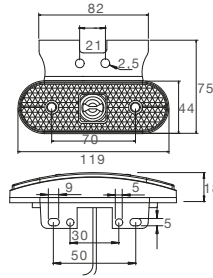

BEST. NR				ZUSATZ			ANSCHLUSS
PART NO				ADD ON			CONNECTOR
31-2100-034	-/-	LED	24V	[A]			offenes Ende open end 1,50 m
31-2107-014	-/-	LED	24V	[A]			3 pol. ASS3 3 pin ASS3 1,50 m
31-2107-024	1/-	LED	24V	[B]			3 pol. ASS3 3 pin ASS3 1,50 m



UNIPOINT DI + SML

ZUBEHÖR / ACCESSORIES

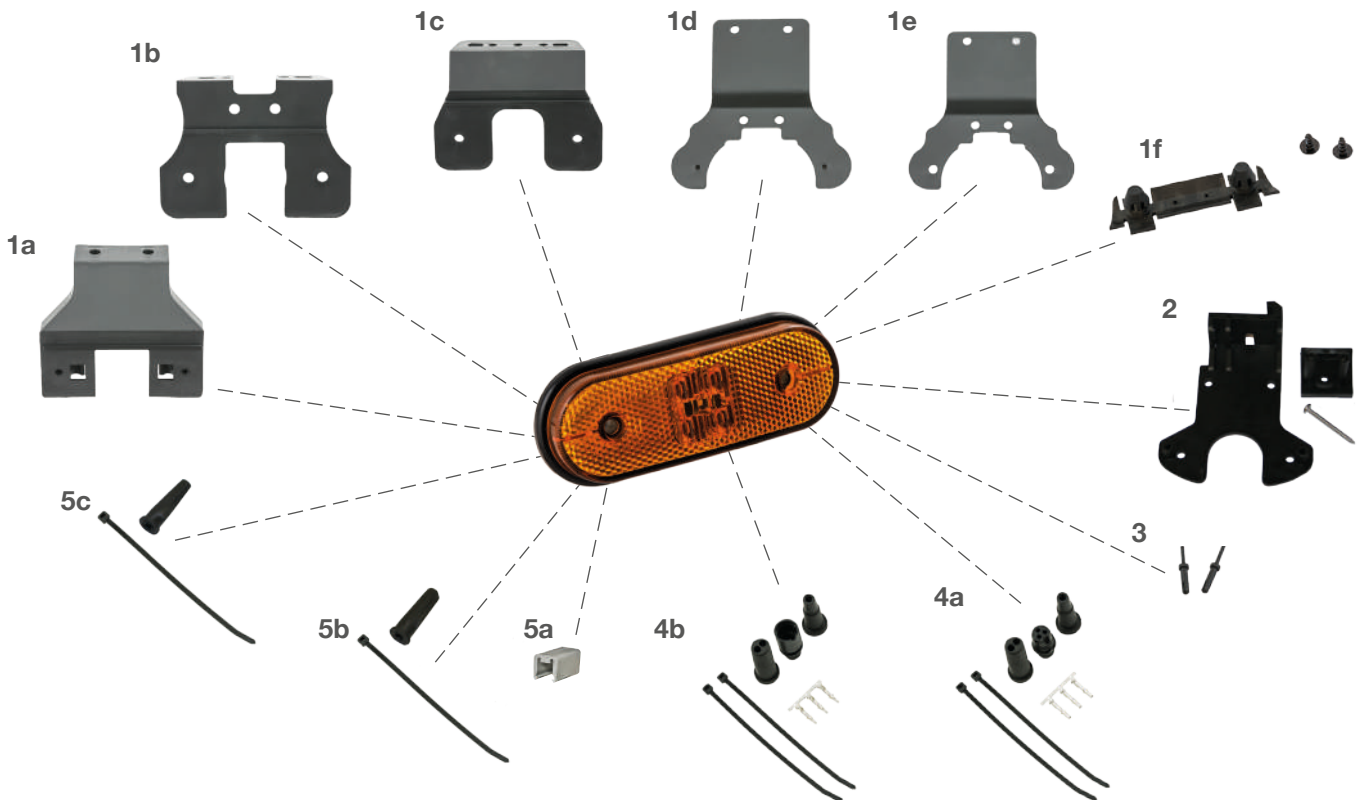

- 1 Haltewinkel | bracket**
- (a) schräg nach hinten
sloping angle to the back
..... 15-5317-014
 - (b) 90° nach hinten
90° to the back
..... 15-5319-004
 - (c) schräg nach vorne
sloping to the front
..... 15-5319-304
 - (d) Aufhängeteil gekröpft (Anbau mit Schrauben)
crumped bracket (screw mounting)
..... 15-5317-004
 - (e) Aufhängeteil gekröpft (Anbau mit Nieten)
crumped bracket (expanding rivet-mounting)
..... 15-5317-024
 - (f) Schnellhalter for SML
quick fixation bracket for SML
..... 15-2128-285

- 2 Verriegelungswinkel | locking bracket**
- Verriegelungswinkel
locking angle
..... 15-5322-004

- 3 Spreizniete | expanding rivet**
14-15 mm 14-4596-004

- 4 ASS3 Verbinder | ASS3 connector**
- (a) 3 pol. weiblich
3 pin female 13-0322-281
 - (b) 3 pol. männlich
3 pin male 13-0332-281

- 5 für P&R Verbinder | for P&R connector**
- (a) Verschlusskappen
caps 15-5971-014
 - (b) Endkappen rund
end caps round 15-5983-024
 - (c) Endkappen eckig
end caps square 15-5729-014



UNIPOINT MAXX LED

ADR Zone 2 IP 6K9K



Produktinformation
Product information

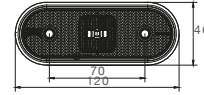

Seitenmarkierungslicht
Sidemarker light

BEST. NR				ZUSATZ	ANSCHLUSS
PART NO				ADD ON	CONNECTOR
31-2104-064	1/-	LED	24V		P&R 2,00 m



UNIPOINT MAXX LED

ZUBEHÖR / ACCESSORIES

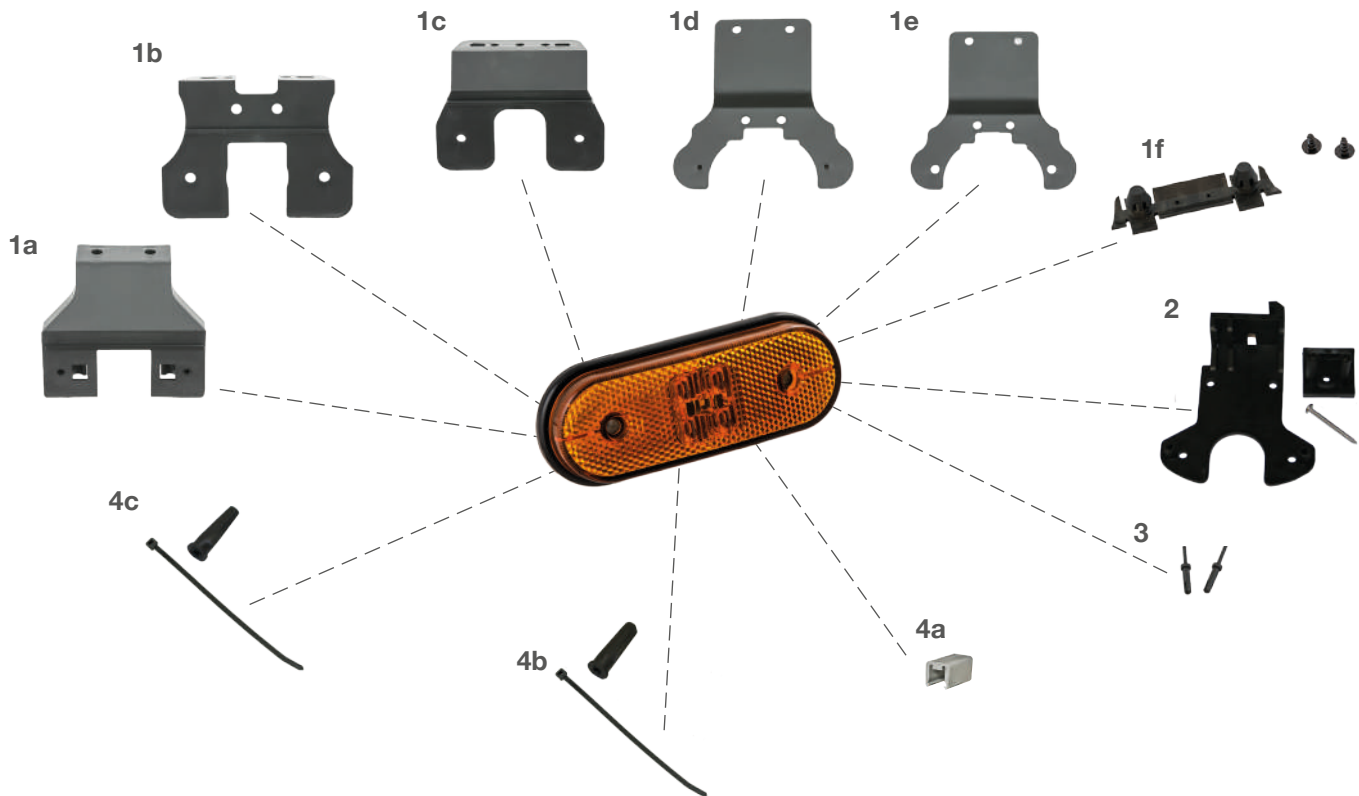

1 Haltewinkel | bracket

- (a) schräg nach hinten
sloping angle to the back
..... 15-5317-014
- (b) 90° nach hinten
90° to the back
..... 15-5319-004
- (c) schräg nach vorne
sloping to the front
..... 15-5319-304
- (d) Aufhängeteil gekröpft (Anbau mit Schrauben)
crumped bracket (screw mounting)
..... 15-5317-004
- (e) Aufhängeteil gekröpft (Anbau mit Nieten)
crumped bracket (expanding rivet-mounting)
..... 15-5317-024
- (f) Schnellhalter for SML
quick fixation bracket for SML
..... 15-2128-285

2 Verriegelungswinkel | locking bracket

- Verriegelungswinkel
locking angle
..... 15-5322-004

3 Spreizniete | expanding rivet

- 14-15 mm 14-4596-004

4 für P&R Verbinder | for P&R connector

- (a) Verschlusskappen
caps 15-5971-014
- (b) Endkappen rund
end caps round 15-5983-024
- (c) Endkappen eckig
end caps square 15-5729-014



SIDEPPOINT

ADR Zone 2

IP 68

[A]

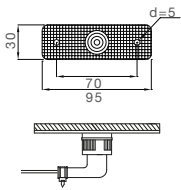

[B]

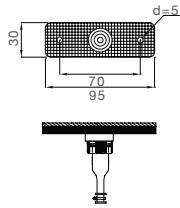

[C]

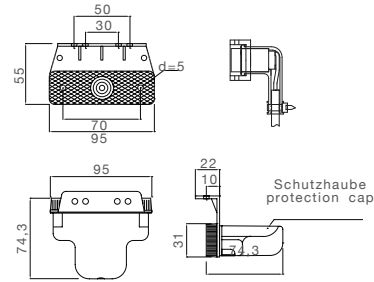

[D]

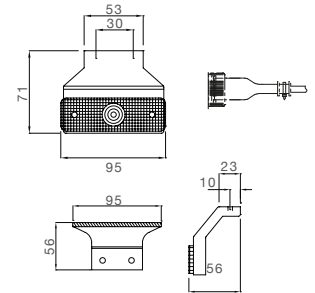

BEST. NR				ZUSATZ	ANSCHLUSS	
PART NO				ADD ON	CONNECTOR	
31-5004-014	-/-		24V	[A]		0,50 m
31-5004-094	1/-		24V	[B]		0,50 m
31-5004-104	1/-		24V	[B]		1,50 m
31-5004-154	1/-		24V	[A]		0,25 m
31-2804-094	1/-		24V	[A]		0,50 m
31-2804-174	1/-		24V	[B]		1,50 m
31-2814-004	1/50		24V	[C]	Schutzhaube protection cap	0,50 m
31-2814-024	1/50		24V	[C]	Schutzhaube protection cap	1,50 m
31-2864-004	1/-		24V	[D]		0,50 m
31-2864-034	1/50		24V	[D]		1,50 m



SIDEPOINT

ZUBEHÖR / ACCESSORIES

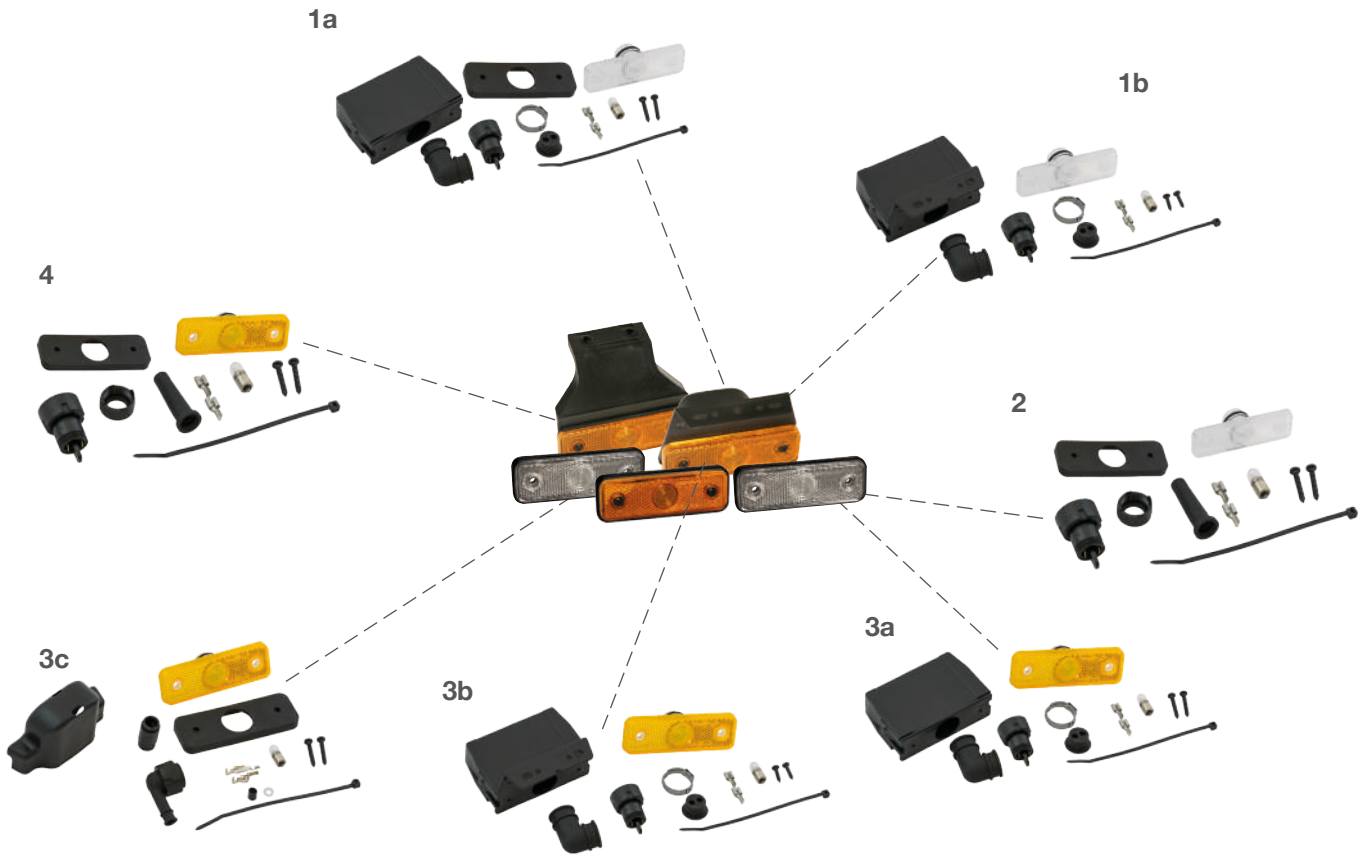

1 Ersatzleuchte weiß mit Schutzhaube | spare part lamp white with protection cap

(a) mit 90° Anschluss ohne Haltewinkel
with 90° connector without bracket
..... 21-5000-004

(b) mit 90° Anschluss und 90° Haltewinkel
with 90° connector and 90° bracket
..... 21-5000-034

2 Ersatzleuchte weiß ohne Schutzhaube | spare part lamp white without protection cap

mit geradem Anschluss ohne Haltewinkel
with straight connector without bracket
..... 21-5000-054

3 Ersatzleuchte orange mit Schutzhaube | spare part lamp orange with protection cap

(a) mit 90° Anschluss ohne Haltewinkel
with 90° connector without bracket
..... 21-2801-004

(b) mit 90° Anschluss und 90° Haltewinkel
with 90° connector and 90° bracket
..... 21-2800-014

(c) mit 90° Anschluss und Schutzhaube
with 90° connector and with protection cap
..... 21-2801-064

4 Ersatzleuchte orange ohne Schutzhaube | spare part lamp orange without protection cap

mit geradem Anschluss ohne Haltewinkel
with straight connector without bracket
..... 21-2801-054





SIDEPOINT

ZUBEHÖR / ACCESSORIES

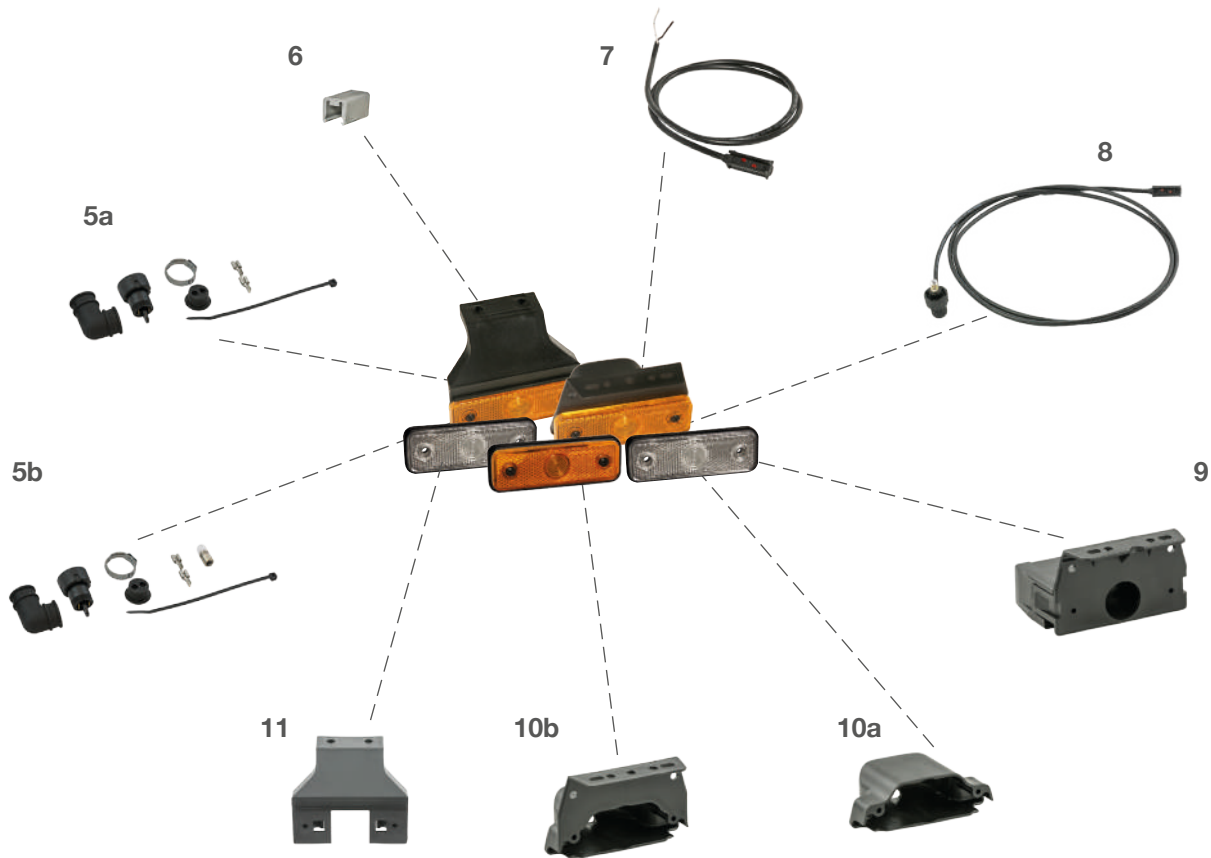

5 Anschluss | connector

- (a) ohne Glühlampe
without bulb..... 15-2128-524
- (b) mit Glühlampe
with bulb..... 15-2128-514

6 Verschlusskappen für P&R Verbinder | caps for P&R connector

- 15-5971-014

7 Anschlusskabel P&R | connection cable P&R

- 0,50 m..... 68-5000-014
- 1,50 m..... 68-5000-034

8 Zuleitung P&R mit Anschluss und Gehäuse für Fassung | front connection P&R with connector and housing for lamp socket

- 2,00 m 31-2804-204

9 Sockel mit Winkel und Schutzhaube | socket with bracket and protection cap

- 15-2128-274

10 Schutzhaube | protection cap

- (a) ohne Haltewinkel
without bracket..... 15-2122-164
- (b) mit 90° Haltewinkel
with 90° bracket..... 15-2122-174

11 Haltewinkel | bracket

- schräg
sloping..... 15-2128-144



POSIPOINT II LED

ADR Zone 2 IP 6K9K

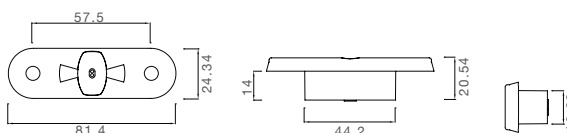

Positionenleuchte
Position Lamp

BEST. NR				ZUSATZ	ANSCHLUSS	
PART NO				ADD ON	CONNECTOR	
31-7100-004	1/-	LED	12V 24V		offenes Ende open end	5,00 m
31-7100-014	1/20	LED	12V 24V		offenes Ende open end	3,50 m
31-7100-034	1/-	LED	12V 24V		offenes Ende open end	1,50 m
31-7100-054	1/-	LED	12V 24V	MAN Version	2 pol. AFS lear 2 pin AFS lear	0,30 m
31-7100-064	1/-	LED	12V 24V		offenes Ende open end	0,50 m
31-7100-114	1/-	LED	12V 24V	mit 7,50 m Wellrohr with 7,50 m corrugated pipe	offenes Ende open end	8,00 m
31-7104-004	1/-	LED	12V 24V		P&R	0,50 m
31-7104-014	1/50	LED	12V 24V		P&R	1,50 m
31-7104-024	1/20	LED	12V 24V		P&R	3,50 m
31-7104-034	1/-	LED	12V 24V	mit Verschlusskappe with cap	P&R	5,00 m
31-7104-054	-/-	LED	12V 24V		P&R	0,15 m
31-7107-014	-/-	LED	12V 24V		2 pol. ASS2 2 pin ASS2	1,30 m
31-7110-004	1/15	LED	12V 24V	mit 7,50 m Wellrohr with 7,50 m corrugated pipe	offenes Ende open end	8,00 m
31-7204-014	1/-	LED	12V 24V		P&R	1,50 m
31-7204-024	1/-	LED	12V 24V		P&R	3,50 m
31-7204-044	1/50	LED	12V 24V		P&R	5,00 m
31-7207-014	1/25	LED	12V 24V		2 pol. ASS3 2 pin ASS3	0,50 m
31-7210-004	1/-	LED	12V 24V	mit 0,30 m Wellrohr with 0,30 m corrugated pipe	offenes Ende open end	0,80 m



POSIPOINT II LED

ZUBEHÖR / ACCESSORIES

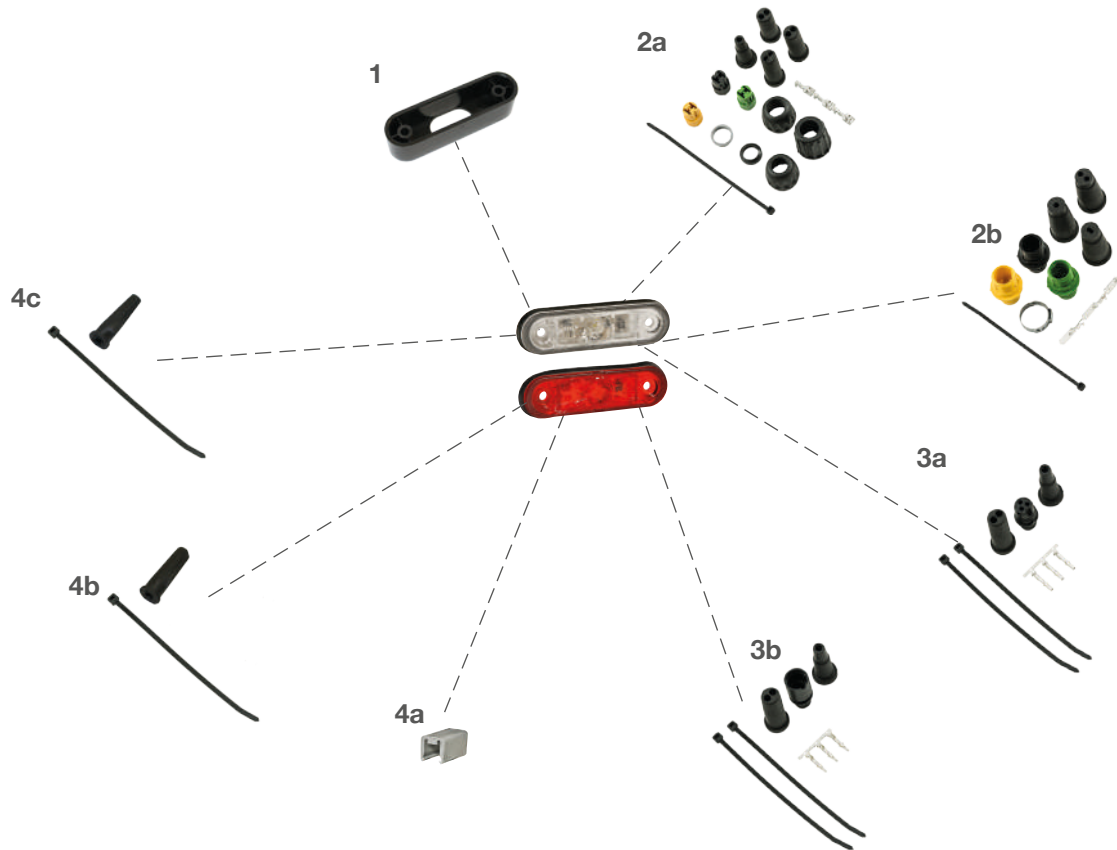

1 Gehäuse | housing
..... 15-5609-104

2 ASS1 & ASS2 Verbinder |
ASS1 & ASS2 connector
(a) 2 pol. weiblich
2 pin female 13-5626-401
(b) 2 pol. männlich
2 pin male 13-5625-991

3 ASS3 Verbinder | ASS3 connector
(a) 3 pol. weiblich
3 pin female 13-0322-281
(b) 3 pol. männlich
3 pin male 13-0332-281

4 für P&R Verbinder |
for P&R connector
(a) Verschlusskappen
caps 15-5971-014
(b) Endkappen rund
end caps round 15-5983-024
(c) Endkappen eckig
end caps square 15-5729-014

4 Dichtungsring |
sealing ring
..... 15-5113-004







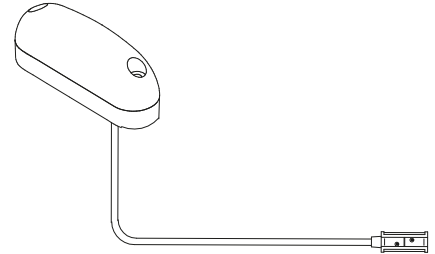
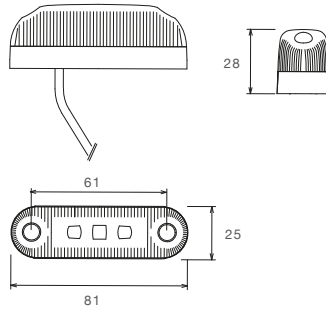







POSIPOINT I LED

ADR Zone 2 IP 6K9K



 Positionslight
Position Light

BEST. NR				ZUSATZ	ANSCHLUSS	
PART NO				ADD ON	CONNECTOR	
31-6004-074	1/-		24V	 	P&R	 0,50 m 
31-6204-084	1/-		24V	 	P&R	 0,50 m 



POSIPOINT I LED

ZUBEHÖR / ACCESSORIES

Positionslampe
Position Lamp

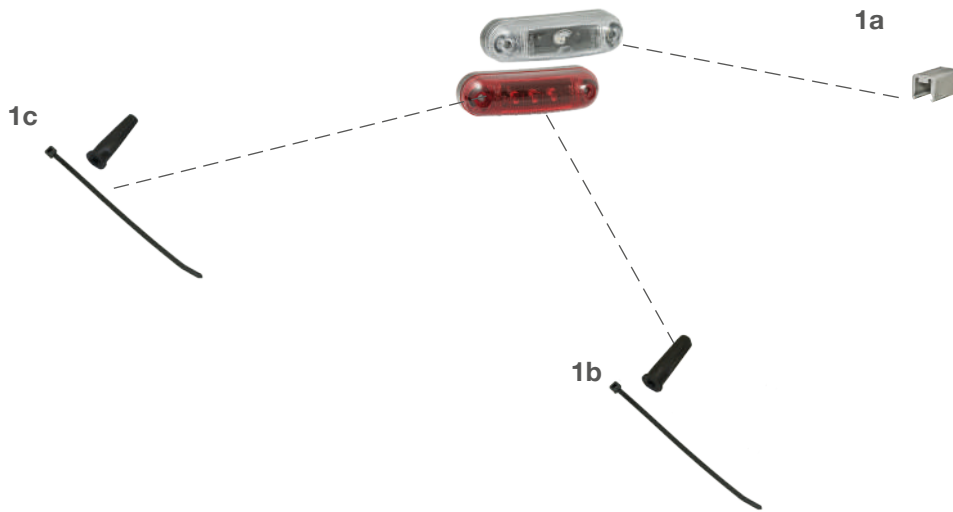

1 für P&R Verbinder I for P&R connector

- (a) Verschlusskappen
caps..... 15-5971-014
- (b) Endkappen rund
end caps round..... 15-5983-024
- (c) Endkappen eckig
end caps square..... 15-5729-014



MONOPOINT II LED

ADR Zone 2 IP 6K9K

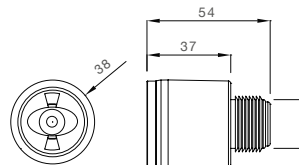
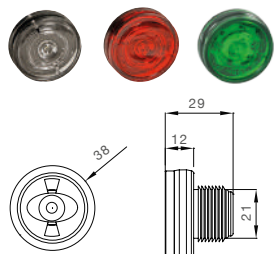

BEST. NR				ZUSATZ	ANSCHLUSS
PART NO				ADD ON	CONNECTOR
31-6700-024	1/-	LED	12V 24V		offenes Ende open end 3,50 m
31-6704-064	1/-	LED	12V 24V		P&R 0,50 m
31-6704-074	1/-	LED	12V 24V		P&R 1,50 m
31-6704-084	1/-	LED	12V 24V		P&R 3,50 m
31-6704-124	1/-	LED	12V 24V		P&R 5,00 m
31-6704-204	1/-	LED	12V 24V		P&R 1,70 m
31-6707-054	-/-	LED	12V 24V		3 pol. ASS3 ♀ 1,50 m
31-6700-044	1/-	LED	12V 24V		2 pol. MKR plus Lear ♀ 0,50 m
31-6700-064	-/-	LED	12V 24V		2 pol. Superseal ♀ 0,25 m
31-6700-014	1/-	LED	12V 24V	+ [A]	offenes Ende open end 3,70 m
31-6700-034	1/10	LED	12V 24V		offenes Ende open end 3,50 m
31-6704-094	1/-	LED	12V 24V		P&R 0,50 m
31-6704-104	1/-	LED	12V 24V		P&R 1,50 m
31-6704-114	1/-	LED	12V 24V		P&R 3,50 m



MONOPOINT II LED

ADR Zone 2 IP 6K9K

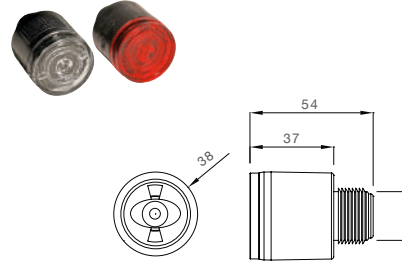
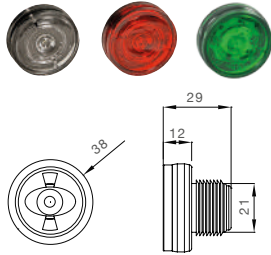





BEST. NR PART NO				ZUSATZ ADD ON	ANSCHLUSS CONNECTOR	
31-6800-014	1/-	LED	12V 24V		offenes Ende open end	3,50 m
31-6804-064	1/-	LED	12V 24V		P&R	3,50 m
31-6804-084	1/-	LED	12V 24V		P&R	0,50 m
31-6804-094	-/-	LED	12V 24V		P&R	5,00 m
31-6807-014	-/-	LED	12V 24V		3 pol. ASS3 3 pin ASS3	0,50 m
31-6804-074	1/-	LED	12V 24V		P&R	3,50 m
31-7400-004	-/-	LED	12V 24V		offenes Ende open end	3,50 m
31-7400-014	-/-	LED	12V 24V		offenes Ende open end	1,00 m

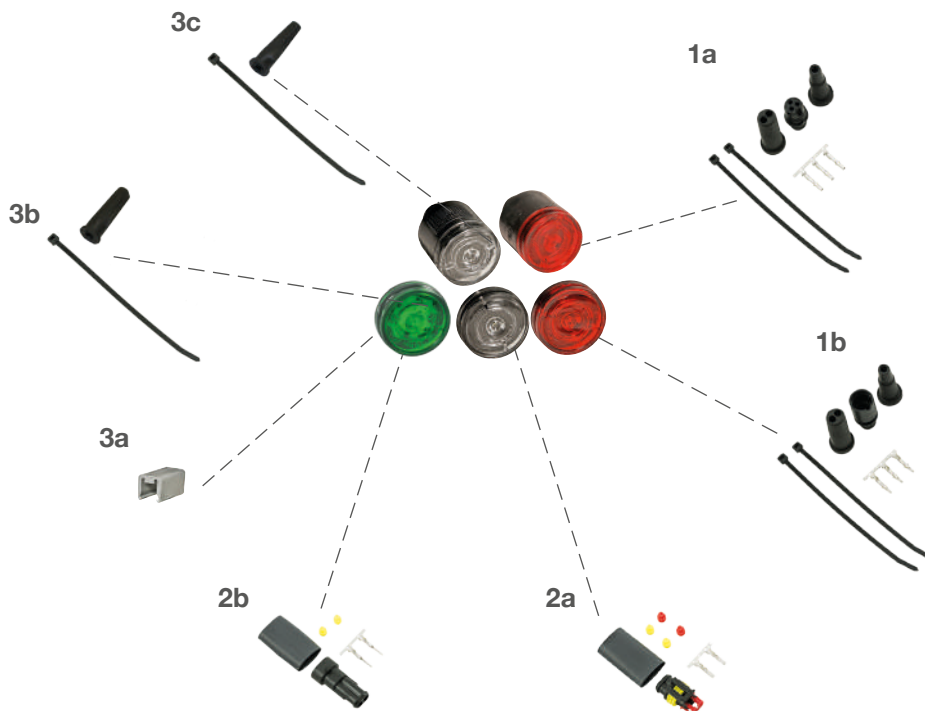

MONOPOINT II LED

ZUBEHÖR / ACCESSORIES



- 1 ASS3 Verbinder | ASS3 connector**
- (a) 3 pol. weiblich
3 pin female 13-0322-281 
 - (b) 3 pol. männlich
3 pin male 13-0332-281 
- 2 Superseal Verbinder | Superseal connector**
- (a) 2 pol. weiblich
2 pin female 15-7002-044 
 - (b) 2 pol. männlich
2 pin male 15-7002-054 

- 3 für P&R Verbinder | for P&R connector**
- (a) Verschlusskappen
caps 15-5971-014 
 - (b) Endkappen rund
end caps round 15-5983-024 
 - (c) Endkappen eckig
end caps square 15-5729-014 







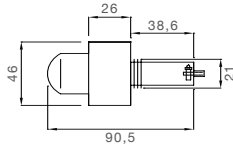

























MONOPOINT I LED

ADR Zone 2 IP 6K9K



 Positionslight
Position Light

BEST. NR				ZUSATZ	ANSCHLUSS
PART NO				ADD ON	CONNECTOR
31-6704-014	1/-	LED	12V 24V	 	P&R  0,50 m 
31-6704-054	1/10	LED	12V 24V	 	P&R  3,50 m 
31-6707-044	-/-	LED	12V 24V	 	3 pol. ASS3   3,50 m 
31-6707-004	1/50	LED	12V 24V	 	2 pol. ASS2   1,50 m 
31-6804-014	1/-	LED	12V 24V	 	P&R  0,50 m 
31-6807-024	1/50	LED	12V 24V	 	3 pol. ASS3   0,50 m 



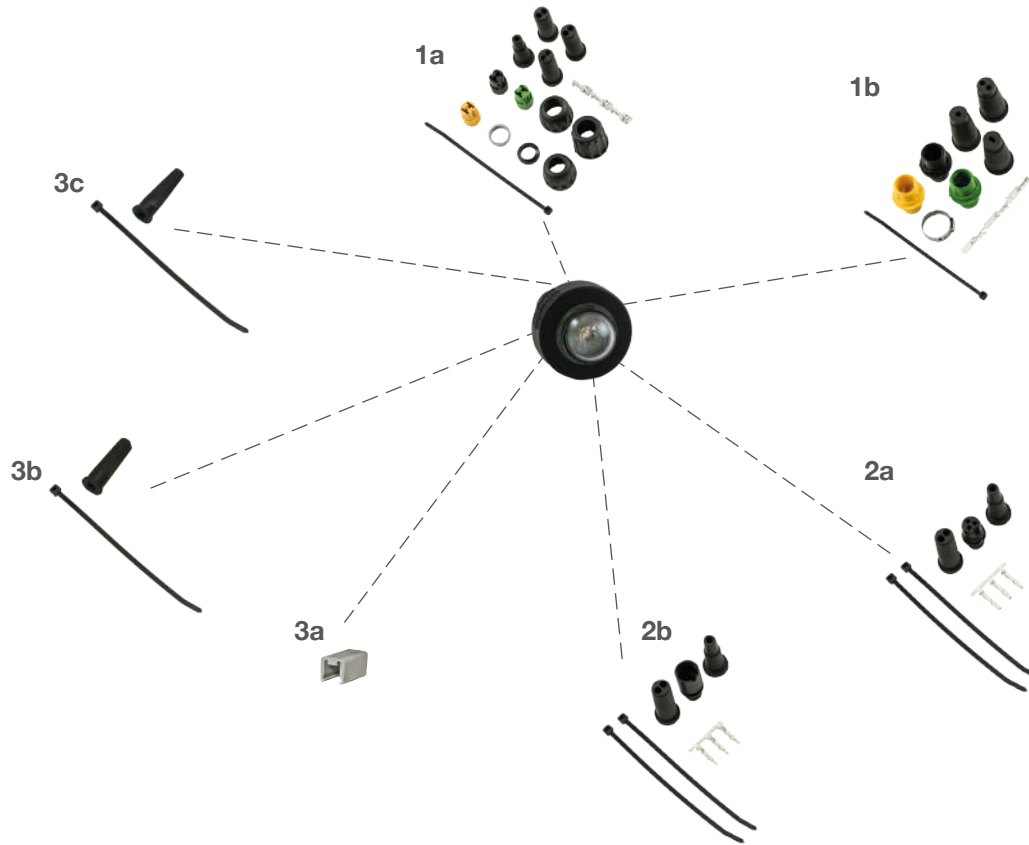

MONOPOINT | LED

ZUBEHÖR / ACCESSORIES



1 ASS1 & ASS2 Verbinder | ASS1 & ASS2 connector

- (a) 2 pol. weiblich
2 pin female 13-5626-401 
- (b) 2 pol. männlich
2 pin male 13-5625-991 

2 ASS3 Verbinder | ASS3 connector

- (a) 3 pol. weiblich
3 pin female 13-0322-281 
- (b) 3 pol. männlich
3 pin male 13-0332-281 

3 für P&R Verbinder | for P&R connector

- (a) Verschlusskappen
caps 15-5971-014 
- (b) Endkappen rund
end caps round 15-5983-024 
- (c) Endkappen eckig
end caps square 15-5729-014 

