



**24V** OEM  
PRODUCT CATALOGUE

## GENERAL

- 04 Introduction
- 08 The system

## LAMPS

- 13 Rear lamps
- 42 Position lamps
- 56 End-outline marker lamps
- 62 Number plate lamps
- 68 Number plate holder
- 74 Work & reversing lamps
- 78 FlexLED LED strips  
& interior lamps



## ACCESSORIES

- 102 SMCG - Side Marker Control Gear
- 104 ERD - Electronic Reversing Device
- 105 Reversing alarms
- 106 LCG - LED control gear
- 108 RDC - Ramp Distance Control Premium
- 110 RADC 1.0 - RADAR Distance Control 1.0
- 112 Smartlink
- 114 Expansions
- 115 Contour markings
- 116 Underrun protection

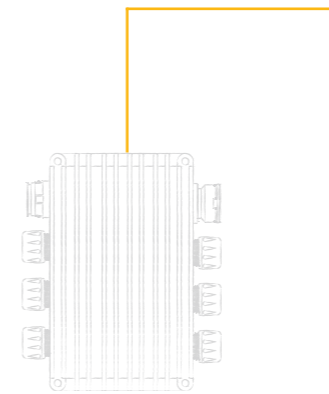

# CONTENTS

## WIRING & JUNCTION BOXES

- 92 Feed line
- 94 Main cable
- 95 Side marker lamp wiring
- 96 Junction box & wiring

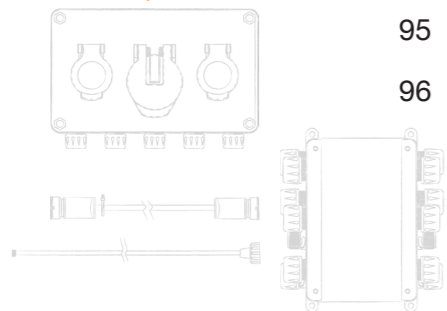

## WIRING SOLUTIONS

- 120 Standard wiring with SMCG
- 121 Standard wiring with flashing side marker lamps

## MOUNTING REGULATIONS

- 124 Rear lighting
- 128 Side lighting
- 129 Front lighting

## APPENDIX

- 132 Plug-in diagram
- 135 Pictogram overview

**Individual systems – satisfied customers.** Since its founding in 1977, Aspöck Systems GmbH has focused on a philosophy that has made it one of the leading manufacturers in the field of lighting for the automotive industry today: The development of customised solutions for each individual customer. This flexibility is the reason for the success of Aspöck systems.

**Innovative products.** We see it is our obligation to create state of the art wiring and lamps, and as pioneers in this field, to also set standards. We rely on water-proof cable and plug-in systems and LED lighting for all areas of application.

**Continuous growth.** We have been continuously expanding our main plant in Peuerbach, Upper Austria, in recent years to include production, storage and administration areas. Every year we invest in new production facilities and test and development equipment, which is how we remain at the cutting edge of technology. At the same time, we continue to educate and train our employees in order to always be able to give you the right answer, even with more difficult questions, for example questions surrounding special regulations.

# WE BRING THE LIGHT TO THE STREETS



# FROM THEN TO NOW

AND ON INTO THE FUTURE...

Aspöck was founded for the production of lighting for agricultural vehicles

'77

Construction of the production facility in Peuerbach

'81

Takeover of Fabrilcar

New customers:  
Motorcycle manufacturers

'07

Change of company name from Fabrilcar to Aspöck Portugal

'08

Development of the first Aspöck plug-in system

'82

Aspöck Germany was founded

'88

New customers:  
Caravan Manufacturers

'91

Commissioning of automated high-bay warehouse in Peuerbach

'09

Production site extension in Portugal

'11

Aspöck Poland was founded

'12

New office building Peuerbach

ECOLED II rear lamp

ASPÖCK LumEU

'18

Completion of the first Aspöck "Multipoint" lamp

'96

New customers:  
Truck trailer manufacturers

'92

New customers:  
Bicycle rack manufacturers

'97

Aspöck Iberica was founded

'99

"Europoint III" The first lamp with "Light Guide" for trailers

Aspöck Turkey was founded

'13

Expansion of Polish automotive production site

'19

AgriLED I & AgriLED II first agricultural rear lamps

'20

Production site extension in Portugal

'15

Opening of Polish production site

'16

Expansion of incoming goods department and picking warehouse Site: Peuerbach

'22

Participation PAGG Aspöck

'03

Introduction of overmoulding technology for connectors

'04

Aspöck UK was founded  
Aspöck France was founded  
Aspöck do Brazil was founded

'01

New customers:  
LKW manufacturers  
Aspöck Norden was founded

'05

New customers  
car manufacturers

'06

New office and logistics building French site

'17

# THE ASPÖCK CONNECTOR SYSTEM

The Aspöck connector system consists of 2-, 3-, 7- and 17-pin plug and socket housings. Each of these wiring systems can be used individually for all 24 V trailers. Aspöck connector systems allow easy connection to all components. All connectors are overmoulded and tested according to protection classification IP69K (jet-proof and submersible).



**17-pin ASS3 plug**  
IP 6K9K

The 17-pin plug and socket housings connect the front supply, main cable and rear wiring as well as ensure easy integration of an additional distributor.



**7-pin ASS2 plug**  
IP 6K9K

Aspöck rear lamps are connected to the Aspöck connector system by the 7-pin plug. These 7-pin plug and socket housings can of course be used for other additional functions.



**3-pin ASS3 plug**  
IP 6K9K

The 3-pin ASS3 connector enables easy and flexible mounting due to its small diameter. The ASS3 can also be used for additional 3-pin functions.



**2-pin ASS2 plug**  
IP 6K9K

The 2-pin ASS2 plug is an advancement of the 2-pin ASS1 plug – the advantage for you is an additional bayonet lock. This enables quick and safe connection of e.g. navigation lights, side marker lamps and end-outline marker lamps as well as additional 2-pin functions.

## Press & Ready system | P&R IP 6K9K

The P&R wiring system is another contact option characterised by quick and uncomplicated mounting on the vehicle. All Aspöck single-function lights can be equipped and connected with the P&R system.

The cables are supplied in different lengths according to requirements. These lamps can be mounted in a 2-core flat cable at any point and are already tested for function. They are totally waterproof due to silicone single-core sealing and may also be used in the transportation of hazardous goods.



**AMP**  
4 / 7-pin

**Superseal**  
2 to 6-pin



**Deutsch**  
2 to 8-pin

**HDSCS**  
2 to 18-pin



## Other connector systems

In addition to the Aspöck connector system, the Aspöck Group offers a wide range of standard connector systems which are available from stock, meaning we can offer maximum flexibility.



# LIGHT SYSTEM

## Aspöck lets you shine

The production of the entire light system ensures that all Aspöck components – first and foremost the lamps, but also the accessories (LCG, SMCG), the junction boxes, etc. – can be perfectly interconnected, guaranteeing maximum reliability (up to ADR and IP6K9K).

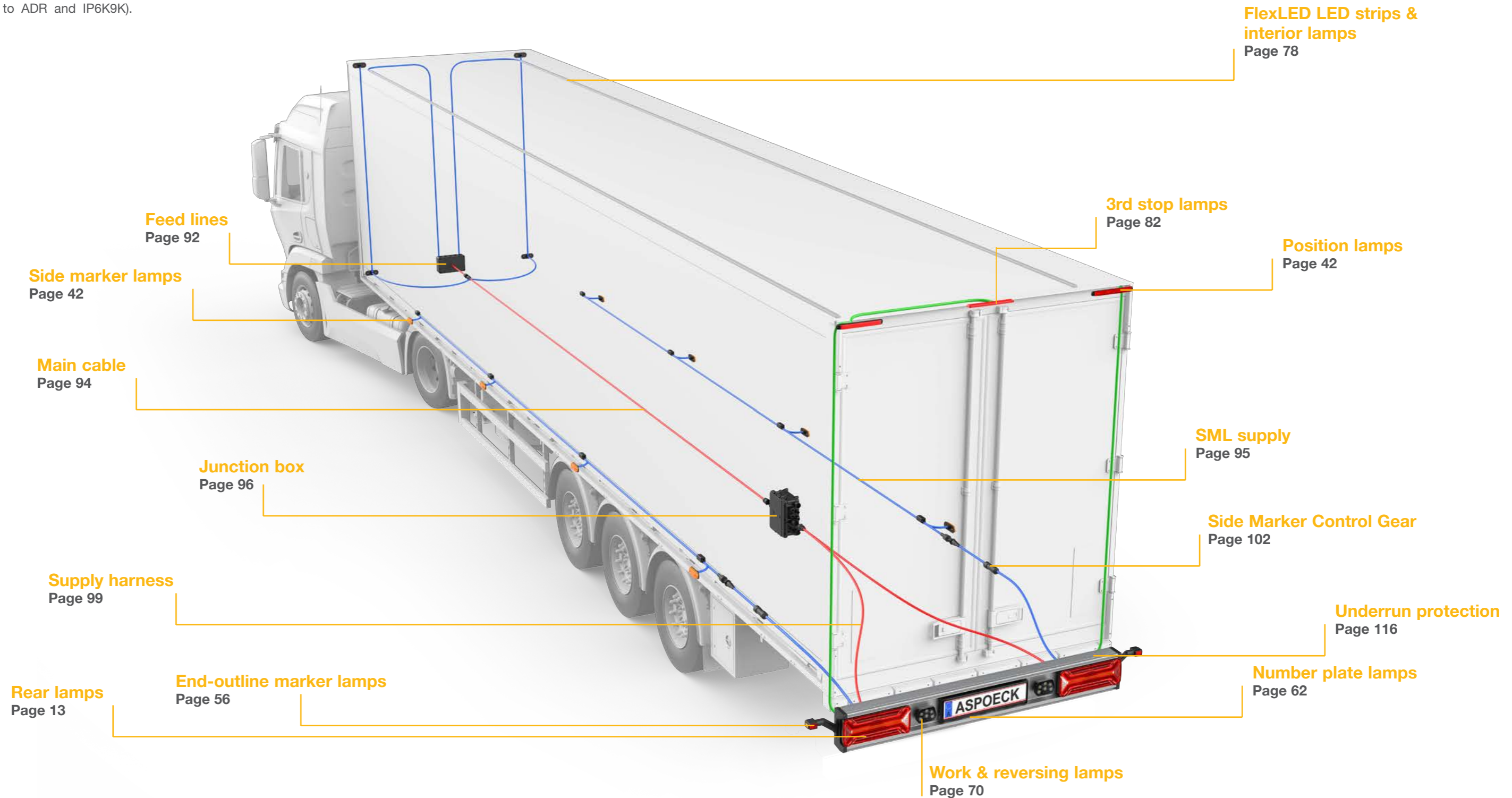

# REAR LAMPS

3-CHAMBER LAMP

ECOLED

ECOLED II

MULTILED III

EUROPOINT III

BRASPOINT 140

NUMBER PLATE LAMPS

BEACONS

INTERIOR LAMPS

WORK LAMPS

NUMBER PLATE HOLDERS

SIDE MARKER LAMPS

REVERSING LAMPS

E LIGHT

POSITIONS LAMPS

OUTLINE MARKER LAMPS

REAR LAMPS

NUMBER PLATE LAMPS

BEACONS

INTERIOR LAMPS

LAMPS

NUMBER PLATE HOLDERS

Aspöck Systems stands out not only for its many wiring solutions, but also its wide range of rear lamps. The quality of the products is of top priority, meaning all light lenses are resistant to chemicals, acids and scratches.

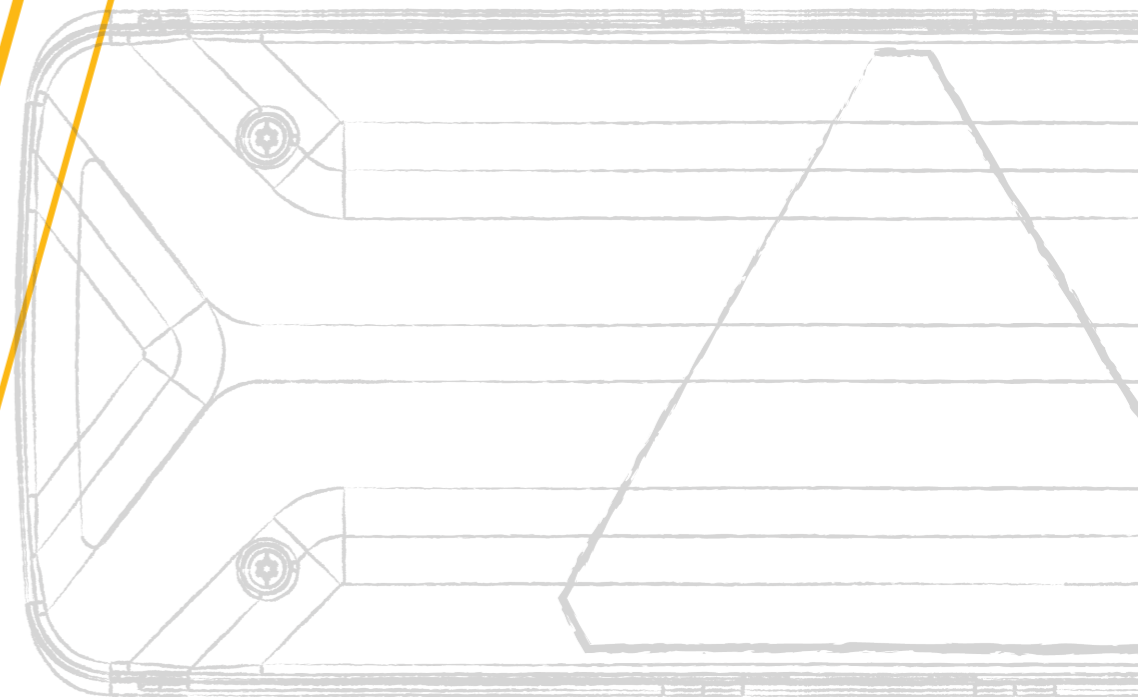

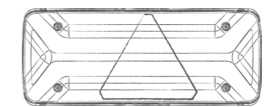

# ECOLED III

The 5-function light from Aspöck Systems

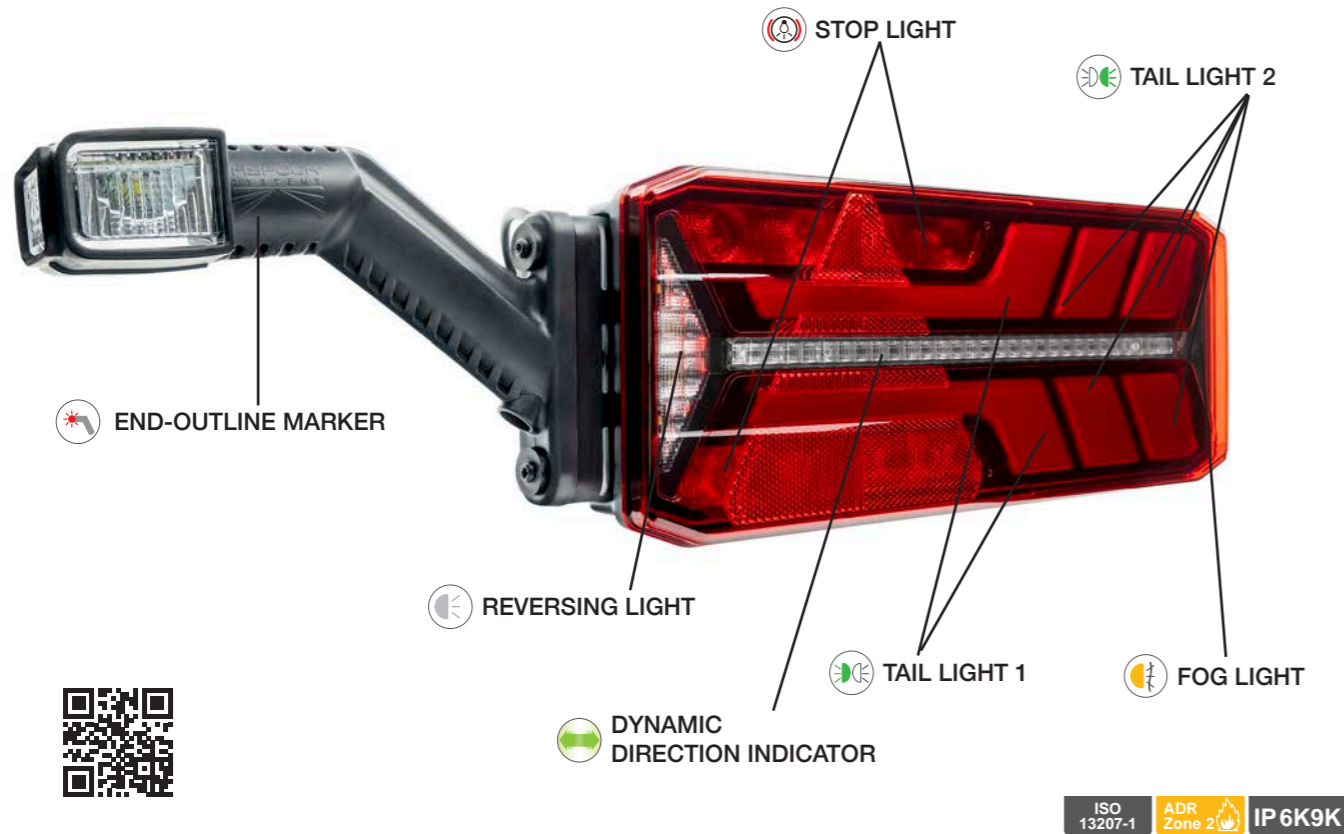

ISO 13207-1 ADR Zone 2 IP 6K9K

## PRODUCT FEATURES

### INCREASED VISIBILITY

Large Glowing Body light surfaces

### REAR LIGHT CROSS-CIRCUIT

Increased safety due to separate supply of the rear light

### DYNAMIC DIRECTION INDICATOR

Sequential directional indicator function

### ISO PULSE CAPABLE

Direction indicator failure monitoring according to ISO 13207-1

### OPTIONAL CONNECTIONS

The option of four additional 2-pin connections on the rear of the lamp

### INTEGRATED SMCG (Side Marker Control Gear)

Control for flashing side marker lamps

### OUTLINE MARKER WITH PREDETERMINED BREAKING POINT

In the event of damage, only the mounting bracket needs to be replaced

### HIGH IP CLASS IP6K9K

Pressure and water resistant

Version WITH OUTLINE MARKER



Version TRAILER

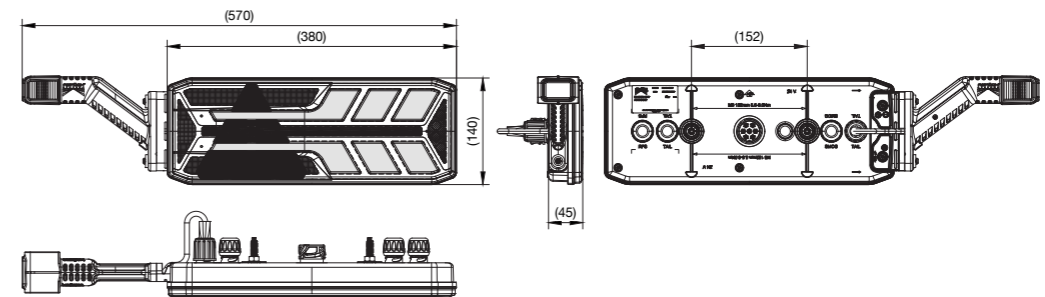

← PART NO.	→ PART NO.	Box	Light	V	LED	ADDITION	CONNECTION
25-4123-017	25-4122-017	1/-	LED	24 V			7-pin ASS2
25-4123-027	25-4122-027	1/-	LED	24 V			7-pin ASS2 4 x 2-pin ASS2
25-4123-037	25-4122-037	1/-	LED	24 V	LED		7-pin ASS2 2 x 2-pin ASS2
25-4123-047	25-4122-047	1/-	LED	24 V			7-pin AMP
25-4123-057	25-4122-057	1/-	LED	24 V			7-pin AMP 4 x 2-pin Superseal
25-4123-067	25-4122-067	1/-	LED	24 V	LED		7-pin AMP 2 x 2-pin Superseal



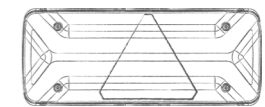

# ECOLED II

Full LED rear lamp with Glowing Body technology



ISO 13207-1 ADR Zone 2 IP54

## PRODUCT FEATURES

### LENS REPLACEABLE

Only one replacement lens, which can be used for the left or right side

### CAN BE USED ON BOTH SIDES

Rear lamp rotates 180 degrees – use left or right

### OUTLINE MARKER WITH PREDETERMINED BREAKING POINT

In the event of damage, only the mounting bracket needs to be replaced

### DYNAMIC DIRECTION INDICATOR

Flashing light function as sequential light

### INCREASED VISIBILITY

Large light surface + homogeneous light pattern

### ISO pulse capable

Direction indicator failure monitoring according to ISO 13207-1

### INTEGRATED SMCG (Side Marker Control Gear)

Control for flashing side marker lamps

### DUAL VOLTAGE

For 12 & 24 volt applications

Version TRAILER



Version TRUCK

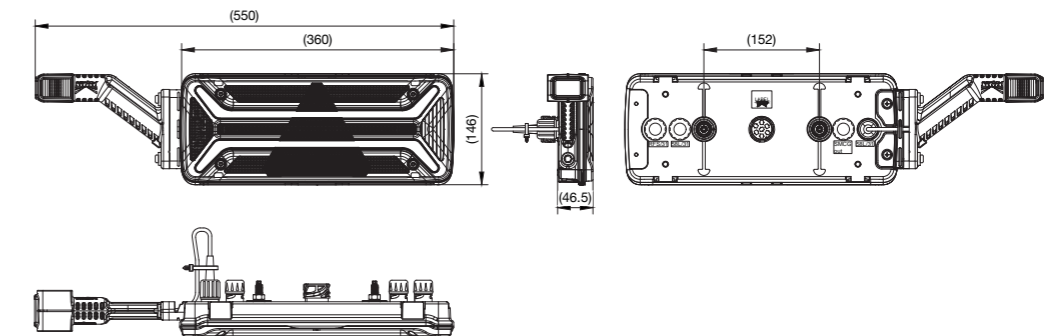

← PART NO.	→ PART NO.	Box	Light	Voltage	LED	Version	Addition	Connection
25-4121-007	25-4120-007	1/8	LED	12V 24V				7-pin ASS2
25-4121-017	25-4120-017	1/8	LED	12V 24V				7-pin ASS2 4 x 2-pin ASS2
25-4121-027	25-4120-027	1/8	LED	12V 24V	LED			7-pin ASS2 4 x 2-pin ASS2
25-4121-037	25-4121-037	1/8	LED	12V 24V				7-pin AMP
25-4121-047	25-4120-047	1/8	LED	12V 24V				7-pin AMP 4 x 2-pin Superseal
25-4121-057	25-4120-057	1/8	LED	12V 24V	LED			7-pin AMP 4 x 2-pin Superseal
25-4121-067	25-4120-067	1/8	LED	12V 24V				7-pin AMP

# EUROPOINT III

Multi-chamber lamp with distinctive fibre optic technology

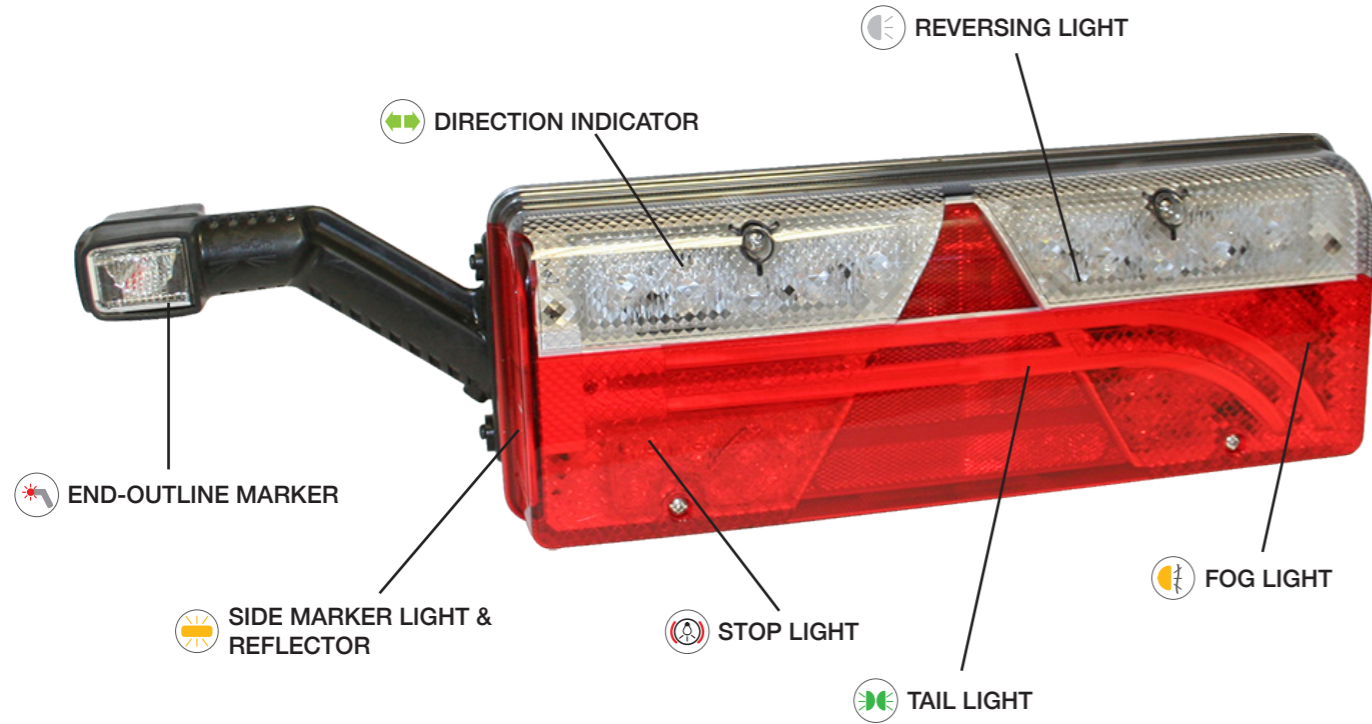

Europoint III FULL LED



Europoint III Truck

ADR Zone 2 IP 56K

## PRODUCT FEATURES

### FIBRE OPTIC TECHNOLOGY

Rear light as "light guide" for a distinctive design

### FLEXIBLE OUTLINE MARKER

Option for direct mounting of an additional flexible LED end-outline marker lamp

### OPTIONALLY INTEGRATED SMCG (Side Marker Control Gear)

Control for flashing side marker lamps

### OPTIONAL CONNECTIONS

Optionally with four additional 2-pin connections on the rear of the lamp

### FULL LED + LCG

Option of full LED rear lamp including direction indicator LCG

### LIGHT BULB + LED CAN BE COMBINED

Functions in light bulb and LED hybrid technology

### LED REAR POSITION LAMP

As standard

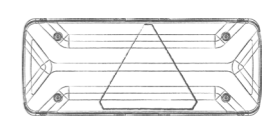

## Version LIGHT BULB



## Version TRUCK

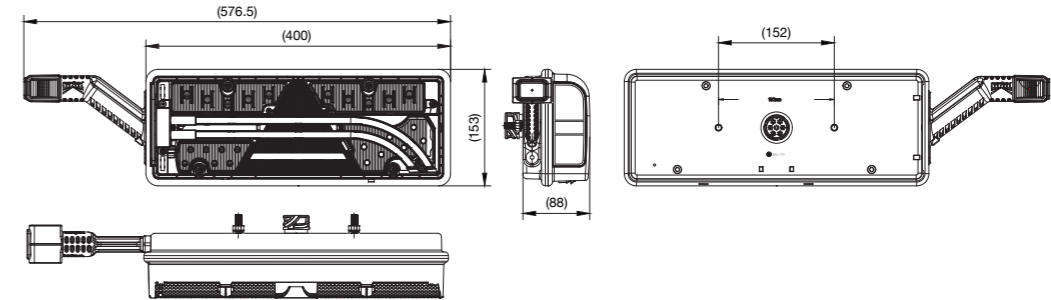

← PART NO.	→ PART NO.					VERSION	ADDITION	CONNECTION
25-7000-507	25-7400-507	1/10		24 V				7-pin ASS2
25-7000-517	25-7400-517	1/10		24 V				7-pin ASS2 4 x 2-pin ASS2
25-7020-507	25-7420-507	1/8		24 V				7-pin ASS2
25-7020-517	25-7420-517	1/8		24 V				7-pin ASS2 4 x 2-pin ASS2
25-7000-707	25-7400-707	1/10		24 V				7-pin ASS2
25-7020-737	25-7420-767	1/8		24 V				7-pin ASS2
25-7000-717	25-7400-717	1/10		24 V				7-pin ASS2 4 x 2-pin ASS2
25-7020-707	25-7420-707	1/8		24 V				7-pin ASS2
25-7000-747	25-7400-747	1/10		24 V				7-pin ASS2
25-7020-717	25-7420-717	1/8		24 V				7-pin ASS2 4 x 2-pin ASS2
25-7000-757	25-7400-757	1/10		24 V				7-pin AMP
25-7000-547	25-7400-547	1/10		24 V				7-pin AMP

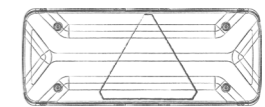

# EUROPOINT II

Many different versions of the rear lamp



## LIGHT BULB

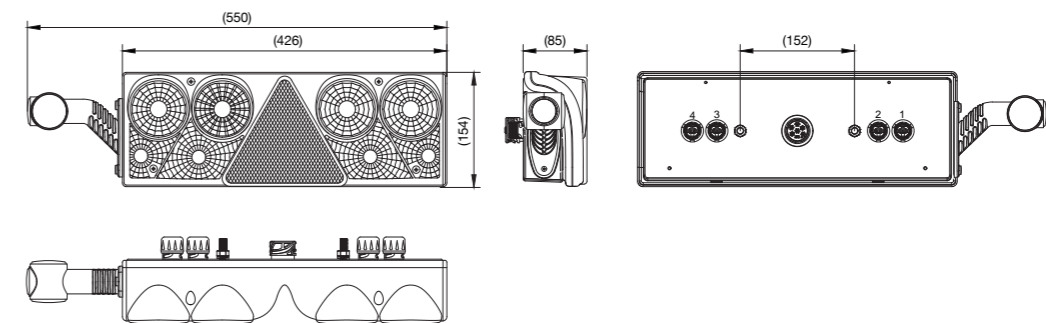

## PRODUCT FEATURES

### PARKING AND STOP LIGHT

Fail-safe thanks to three-piece rear light & two-piece stop light

### FULL LED

All functions possible in LED technology

### REPLACEMENT LENS LEFT AND RIGHT

Spare lens can be used on both sides

### MODULAR LED DESIGN

LED modules are available individually and can be replaced

### SIDE MARKER LAMP

Including side marker lamp

### OPTIONAL CONNECTIONS

Four optional additional 2-pin connections on the rear of the lamp

### OPTIONAL NUMBER PLATE LIGHT

Can be extended with number plate light downwards function

← PART NO.	→ PART NO.		💡	⚡ V	🔦	FUNCTION	CONNECTION
25-6000-707	25-6400-707	1/11	LED	24 V			7-pin ASS2
25-6021-707	25-6421-707	1/9	💡	24 V	LED		7-pin ASS2
25-6000-757	25-6400-757	1/11	LED	24 V			7-pin ASS2
25-6020-757	25-6420-757	1/9	LED	24 V	LED		7-pin ASS2
25-6000-507	25-6400-507	1/11	💡	24 V			7-pin ASS2
25-6001-507	25-6401-507	1/11	💡	24 V			7-pin ASS2
25-6200-507	25-6600-507	1/11	💡	24 V			7-pin ASS2    4 x 2-pin ASS2
25-6011-507	25-6411-507	1/11	LED	24 V			7-pin ASS2    4 x 2-pin ASS2

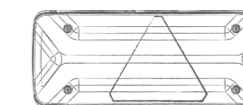

# ECOPOINT II

The compact 5-function light



ADR Zone 2 IP 56K



## PRODUCT FEATURES

### VARIOUS MOUNTING OPTIONS

Can be mounted horizontally / vertically (only for Ecopoint II LED without triangle)

### MODULAR LED DESIGN

LED modules are available individually and can be replaced

### DIFFERENT MODELS

Available for trucks and trailers

### LED TECHNOLOGY

New and reliable design through the use of LEDs

### OPTIONAL CONNECTIONS

Four optional additional 2-pin connections on the rear of the lamp

Version TRAILER



Version TRUCK

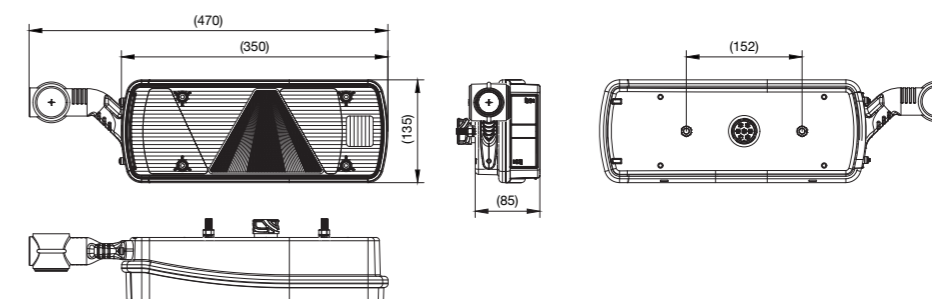

← PART NO.	→ PART NO.					VERSION	ADDITION	CONNECTION
25-2801-707	25-2901-707	1/8	LED	24 V				7-pin ASS2
25-2860-707	25-2960-707	1/8	LED	24 V				7-pin ASS2
25-2800-507	25-2900-507	1/8		24 V				7-pin ASS2
25-2810-507	25-2910-507	1/6		24 V				7-pin ASS2
25-2800-517	25-2900-517	1/8		24 V				7-pin ASS2 2 x 2-pin ASS2
25-2810-517	25-2910-517	1/6		24 V				7-pin ASS2 2 x 2-pin ASS2

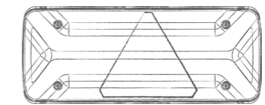

# MULTILED III

Compact LED rear lamp with Glowing Body technology



ISO 13207-1 ADR Zone 2 IP 56

## PRODUCT FEATURES

### INCREASED VISIBILITY

Larger light surfaces for the rear & stop light functions

### MODERN TECHNOLOGY

Innovative Glowing Body Technology for rear light

### LENS REPLACEABLE

Only one replacement lens, which can be used for the left or right side

### DYNAMIC DIRECTION INDICATOR

Sequential directional indicator function

### ISO pulse capable

Direction indicator failure monitoring according to ISO 13207-1

### INTEGRATED SMCG (Side Marker Control Gear)

Control for flashing side marker lamps

### DUAL VOLTAGE

For 12 & 24 volt applications

## Version TRAILER

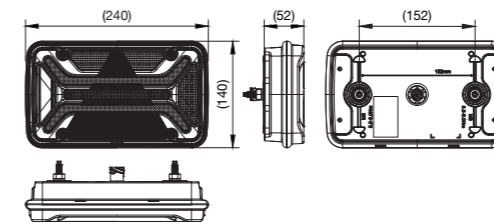

## Version TRUCK

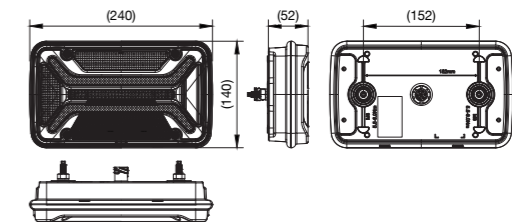

← PART NO.	→ PART NO.				VERSION	ADDITION	CONNECTION
24-8931-007	24-8930-007	1/8	LED	12V 24V			7-pin ASS2
24-8931-017	24-8930-017	1/8	LED	12V 24V			7-pin ASS2 2 x 2-pin ASS2
24-8931-027	24-8930-027	1/8	LED	12V 24V			7-pin AMP 2 x 2-pin ASS2
24-8931-047	24-8930-047	1/8	LED	12V 24V			7-pin AMP
24-8931-037	24-8930-037	1/8	LED	12V 24V			7-pin AMP 2 x 2-pin ASS2
24-8931-057	24-8930-057	1/8	LED	12V 24V			7-pin AMP 2 x 2-pin Superseal
24-8931-067	24-8930-067	1/8	LED	12V 24V			7-pin AMP 2 x 2-pin Superseal
24-8931-077	24-8930-077	1/8	LED	12V 24V			7-pin AMP
24-8931-087	24-8930-087	1/8	LED	12V 24V			7-pin AMP 2 x 2-pin ASS2

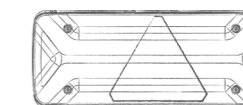

# MULTILED II

The compact 5-function light

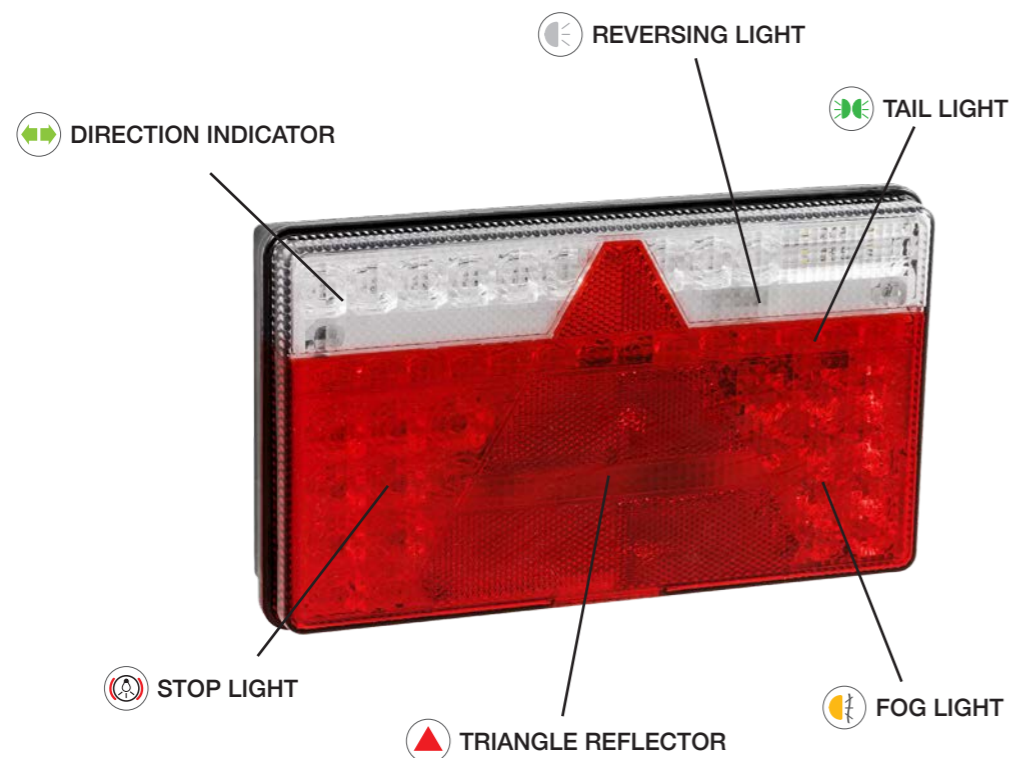

Version **FLAT**



[A]

Version **HIGH**



[B]

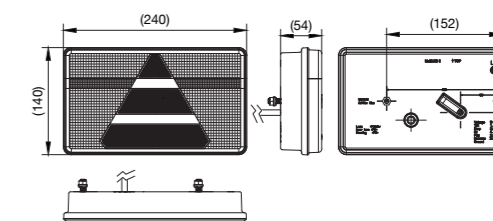
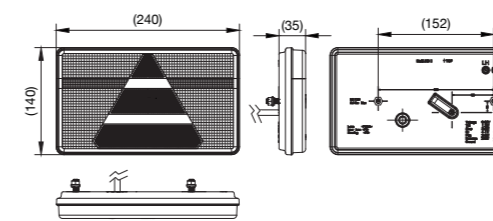

ADR Zone 2 IP 6K9K

## PRODUCT FEATURES

### FULL LED

All functions in LED

### TWO CONSTRUCTION DEPTHS

Available in two different depths (flat and high)

### NUMBER PLATE LIGHTING

Optional number plate light

### DUAL VOLTAGE

For 12 & 24 volt applications

← PART NO.	→ PART NO.	Box	Light	V	VERSION	FUNCTION	CONNECTION	CABLE
35-0201-007	35-0202-007	1/20	LED	12V 24 V	[A]		Open end	0.50 m
35-0201-037	35-0202-037	1/-	LED	12V 24 V	[A]		7-pin ASS2 male	0.50 m
35-0201-047	35-0202-047	1/10	LED	12V 24 V	[A]		7-pin AMP male	0.50 m
35-0203-007	35-0204-007	1/20	LED	12V 24 V	[B]		Open end	0.50 m
35-0203-037	35-0204-037	1/10	LED	12V 24 V	[B]		7-pin ASS2 male	0.50 m
35-0203-047	35-0204-047	1/-	LED	12V 24 V	[B]		7-pin AMP male	0.50 m
35-0203-057	35-0204-057	1/20	LED	12V 24 V	[B]	↔	Open end	0.50 m
35-0203-087	35-0204-087	1/-	LED	12V 24 V	[B]	↔	7-pin ASS2 male	0.50 m
35-0203-097	35-0204-097	1/-	LED	12V 24 V	[B]	↔	7-pin AMP male	0.50 m
35-0203-107	35-0204-107	1/20	LED	12V 24 V	[B]	↔	Open end	0.50 m
35-0203-137	35-0204-137	1/10	LED	12V 24 V	[B]	↔	7-pin ASS2 male	0.50 m
35-0203-147	35-0204-147	1/-	LED	12V 24 V	[B]	↔	7-pin AMP male	0.50 m

# MULTIPOINT V

The compact multi-chamber light

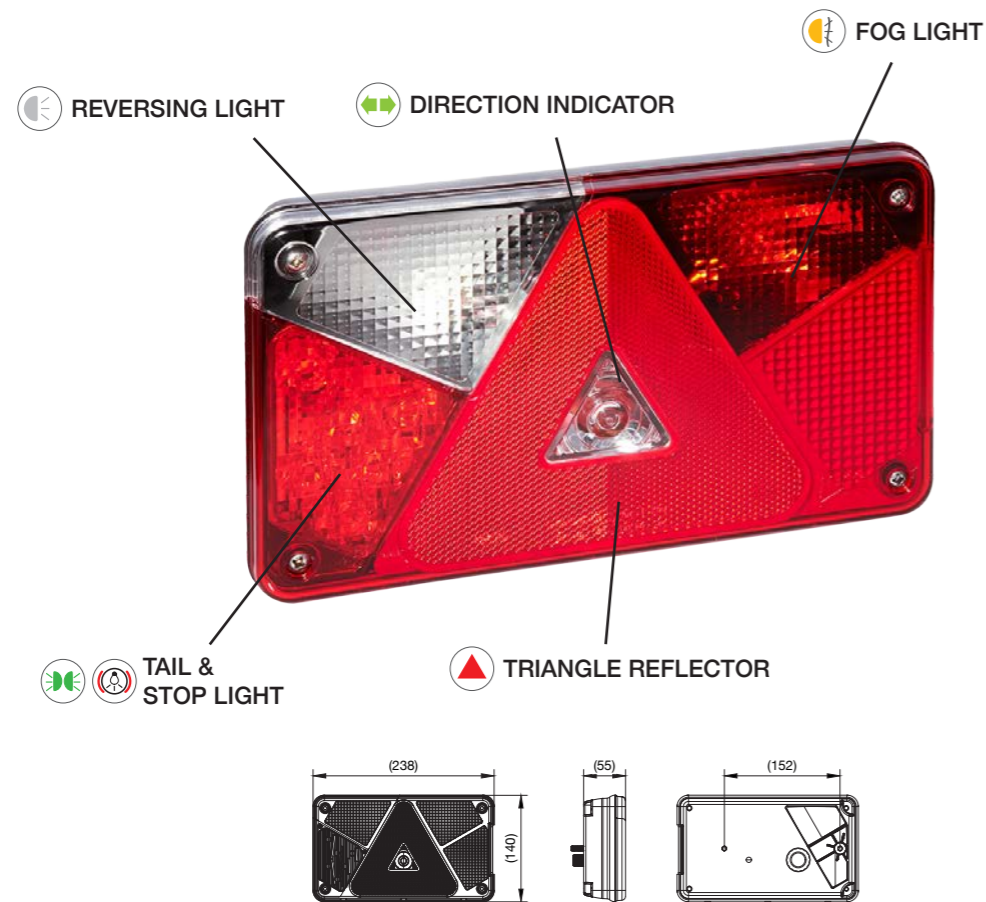

ADR Zone 2 IP 54

## PRODUCT FEATURES

### DESIGN

Compact multi-chamber light with PG screw connection

### STURDY DESIGN

Built-in damping against vibrations

### LED FUNCTIONS

Stop and rear light modular in LED

### DUAL VOLTAGE

For 12 & 24 volt applications

← PART NO.	→ PART NO.	☐	💡	⚡	ADDITION	CONNECTION	CABLE
34-8605-007	34-8806-007	1/-		24 V		7-pin ASS2	0.90 m
34-8505-007	34-8706-007	1/-		24 V		7-pin ASS2	2.50 m

# THE ART OF LIGHTS



TURN IT ITS SAFE  
GLOWs EST ITS SAFE  
ECOLED II SWITCH IT IT GLOWs ITS SAFE

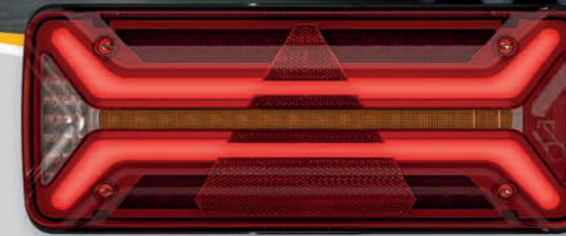

## ECOLED II

FULL LED REAR LAMP WITH GLOWING BODY TECHNOLOGY



The interchangeable lens can be used for the left and right lamp, which likewise applies to the entire tail light when turned 180 degrees.

In comparison to the predecessor models, the visibility of the ECOLED II has also received a definite ASPÖCK upgrade. It features a large light area, uniform light pattern plus sequential light in a dynamic indicator.

Resistant to pressure, water, bases and acids, the rugged tail light features a low installation height and is available in a voltage range from 12 to 24 volts.

[www.aspoeck.com](http://www.aspoeck.com)

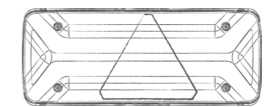

# BRASPOINT 98

The tiny multi-function rear lamp

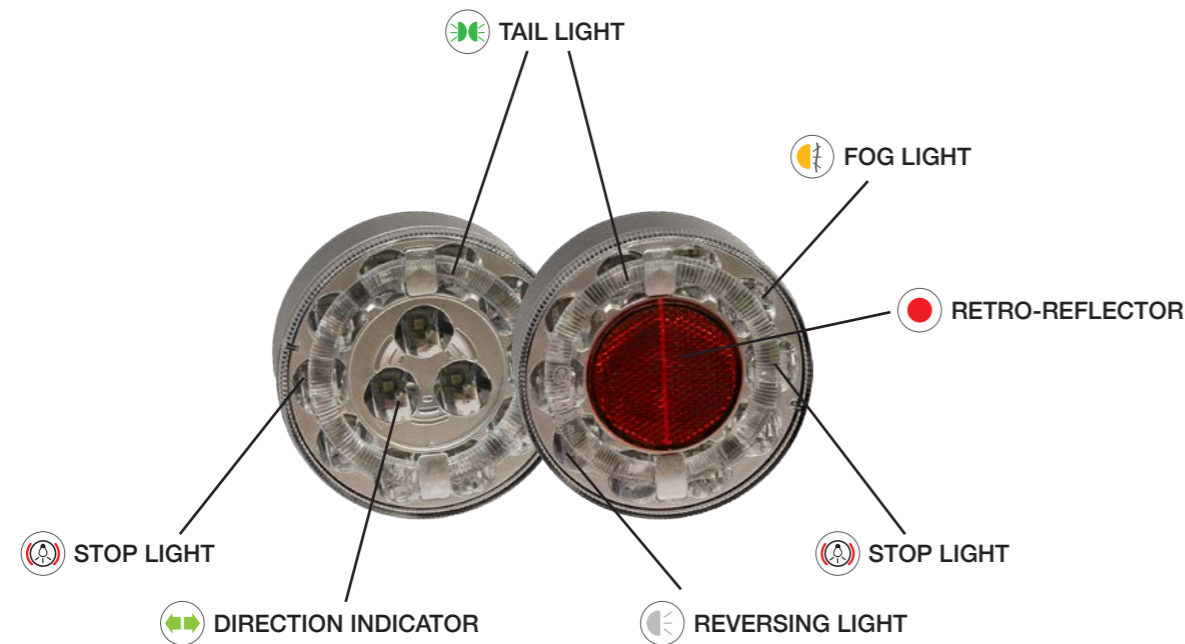

ADR Zone 2 IP 69K

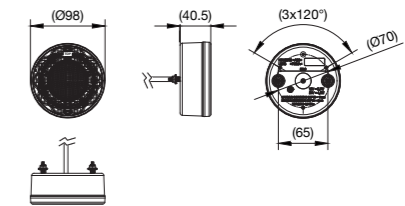
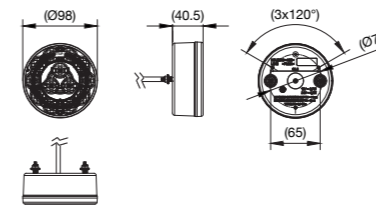

## PRODUCT FEATURES

### FULL LED

All functions in LED

### FIBRE OPTIC TECHNOLOGY

Rear light as "light guide" for a distinctive design

### COMPACT ROUND DESIGN

Ideal for limited space

### CAN BE COMBINED AS REQUIRED

All lamps can be combined according to your requirements

### DUAL VOLTAGE

For 12 & 24 volt applications

← → PART NO.	📦	💡	⚡ V	FUNCTIONS	ADDITION	CONNECTION	CABLE
33-9200-007	1/-	LED	12V 24 V	👁️ 🛑 🚦		Open end	0.50 m
33-9200-017	1/-	LED	12V 24 V	👁️ 🛑 🚦		Open end	7.00 m
33-9207-057	1/-	LED	12V 24 V	👁️ 🛑 🚦		7-pin ASS2 ♂	0.50 m
						7-pin ASS2 ♀	0.20 m
33-8100-107	1/-	LED	12V 24 V	👁️ 🔄 🛑	← →	Open end	0.50 m
33-8107-057	1/-	LED	12V 24 V	👁️ 🔄 🛑		7-pin ASS2	0.50 m
33-8100-007	1/-	LED	12V 24 V	👁️ 🔄 🛑	⏏	Open end	0.50 m
33-8107-007	1/-	LED	12V 24 V	👁️ 🔄 🛑		7-pin ASS2	0.50 m



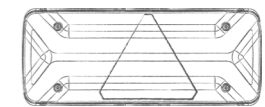

# BRASPOINT 140

Three lamps – many options

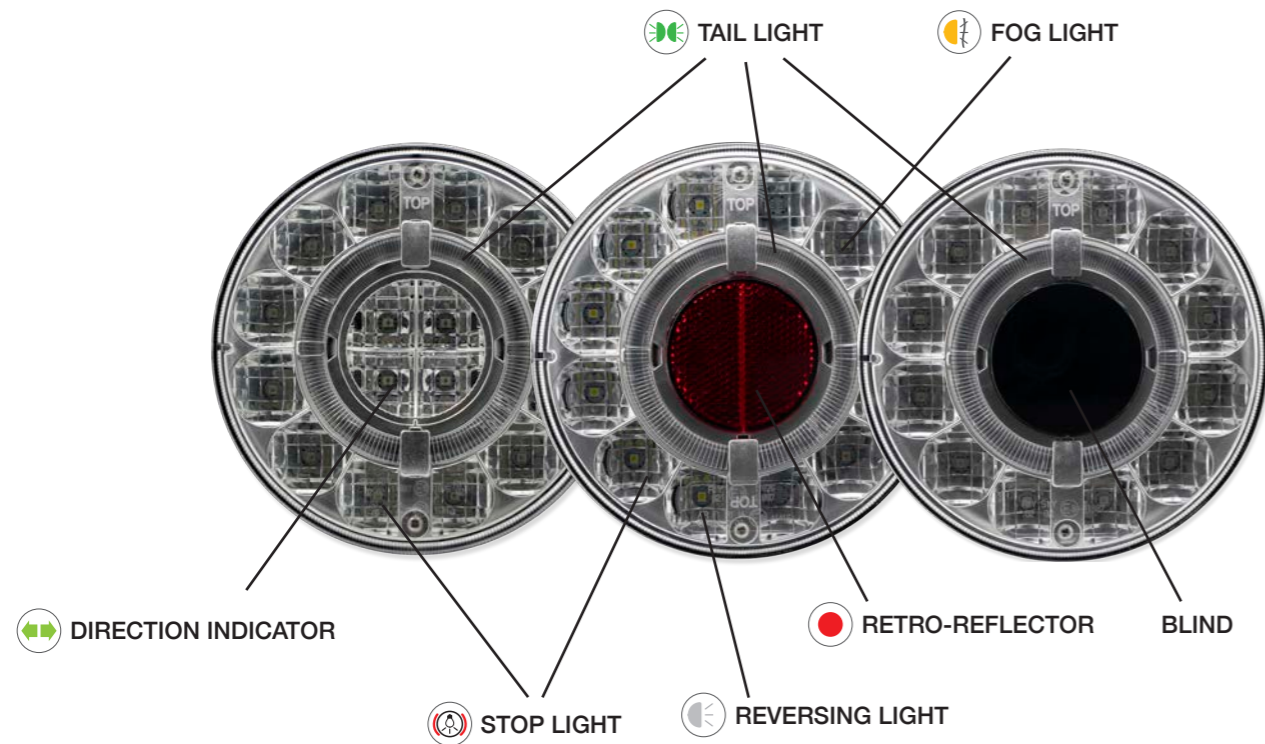

ADR Zone 2 IP 69K

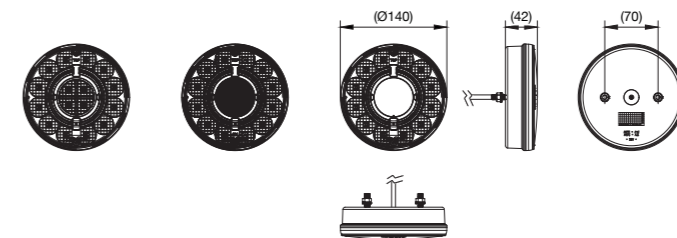

## PRODUCT FEATURES

### FULL LED

All functions in LED

### FIBRE OPTIC TECHNOLOGY

Rear light as "light guide" for a distinctive design

### CAN BE COMBINED AS REQUIRED

All lamps can be combined according to your requirements

### DUAL VOLTAGE

For 12 & 24 volt applications

← → PART NO.				FUNCTIONS	CONNECTION	CABLE
33-8100-207	1/35	LED	12V 24 V		Open end	0.50 m
33-8107-037	1/20	LED	12V 24 V		7-pin ASS2	0.50 m
33-9200-207	1/35	LED	12V 24 V		Open end	0.50 m
33-8107-027	1/20	LED	12V 24 V		7-pin ASS2	0.50 m
33-9207-067	1/20	LED	12V 24 V		7-pin ASS2 ♂	0.50 m
					7-pin ASS2 ♀	0.20 m

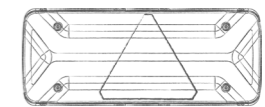

# 3-CHAMBER LAMP LED

The round rear lamp in full LED



ADR Zone 2 IP 54

## PRODUCT FEATURES

### FULL LED

All functions in LED

### HIGHLY DIVERSE VARIANTS

Enabled through special wiring solutions

### CAN BE COMBINED AS REQUIRED

All lamps can be combined according to your requirements

### OPTIONALLY AVAILABLE AS DUAL VOLTAGE

For 12 & 24 volt applications

### SPACE-SAVING ALTERNATIVE

Using flat housing

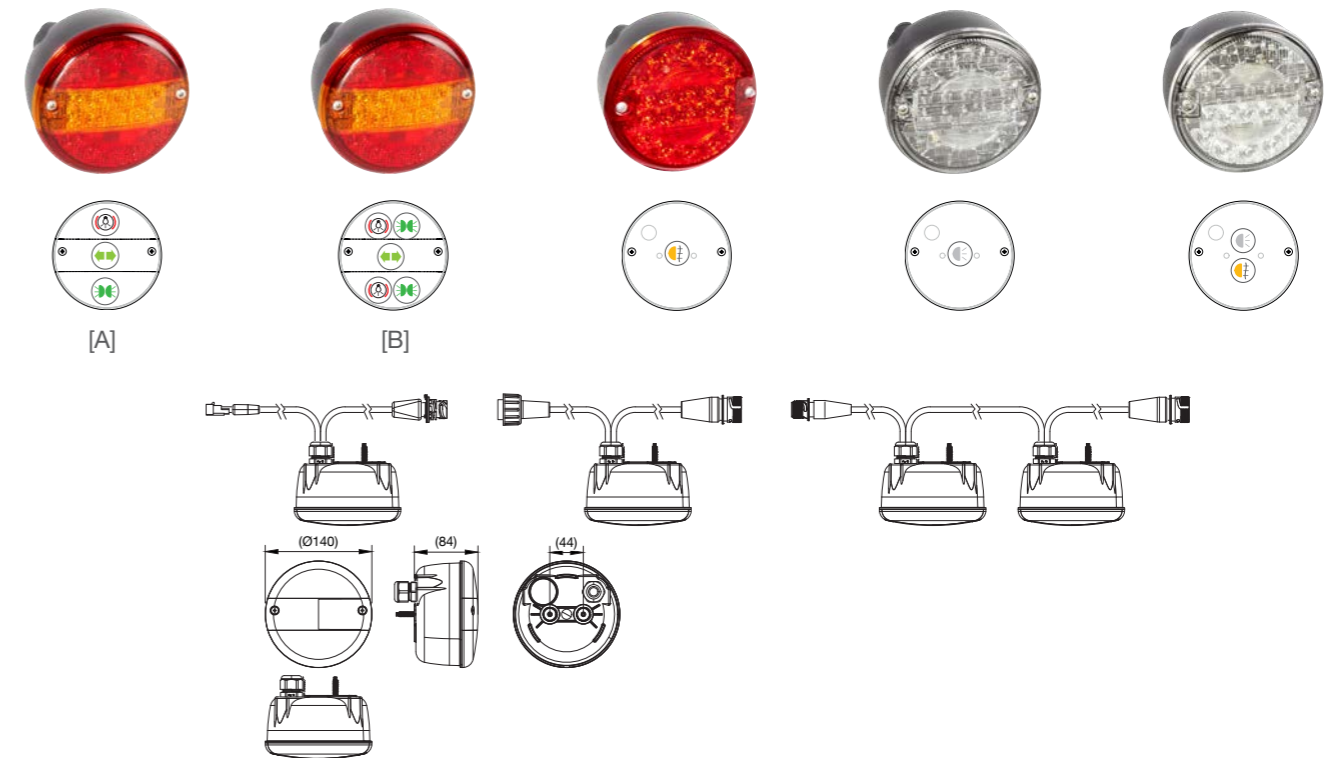

← PART NO.	→ PART NO.	Box	Light	V	FUNCTIONS	ADDITION	CONNECTION	CABLE
33-8403-047	33-8402-047	1/10	LED	12V 24V		[A]	PG 11 screw connection, open end	
33-8405-097	33-8406-097	1/10	LED	12V 24V		[A]	7-pin ASS2	0.50 m
33-8407-017		1/10	LED	24 V		[A]	7-pin ASS2 ♂	0.15 m
33-8407-017		1/10	LED	24 V		[A]	7-pin ASS2 ♀	0.15 m
33-8403-037	33-8402-037	1/-	LED	12V 24V		[B]	PG 11 screw connection, open end	
33-8405-087	33-8406-087	1/3	LED	12V 24V		[B]	7-pin ASS2	0.50 m
37-8407-007		1/10	LED	24 V			2-pin ASS2	1.50 m
37-8407-017		1/1	LED	24 V			7-pin ASS2	0.15 m
38-8407-007		1/-	LED	24 V			2-pin ASS2	1.50 m
38-8107-067		1/-	LED	24 V			7-pin ASS2	0.15 m
32-7000-707		1/-	LED	24 V			7-pin ASS2	1.50 m
39-7007-007		1/10	LED	24 V			7-pin ASS2	0.15 m

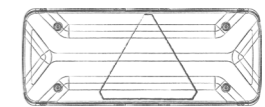

# 3-CHAMBER LAMP II

Three lamps – many options



ADR Zone 2 IP 54

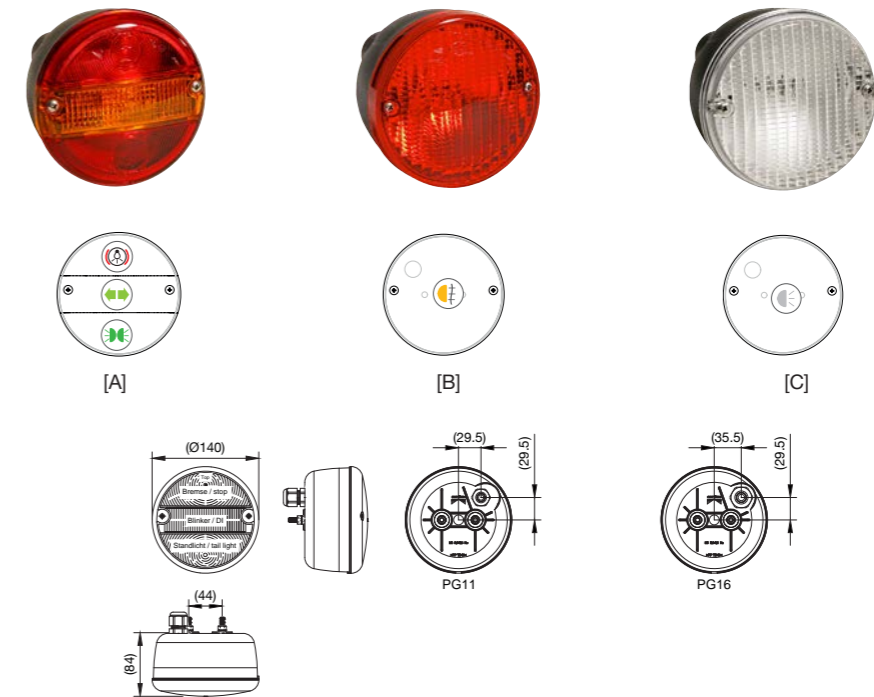

## PRODUCT FEATURES

### TRADITIONAL DESIGN

Popular and well-known light pattern

### FLEXIBLE PROCUREMENT

High availability of spare parts

### HIGHLY DIVERSE VARIANTS

Enabled through special wiring solutions

← PART NO.	→ PART NO.				FUNCTIONS	VERSION	CONNECTION	CABLE
33-8205-037	33-8206-037	1/-		24 V		[A]	7-pin ASS2 ♂	0.50 m
							7-pin ASS2 ♀	0.30 m
33-8205-087	33-8206-097	1/10		24 V		[A]	7-pin ASS2 ♂	1.50 m
							7-pin ASS2 ♀	1.50 m
37-8007-137		1/-		24 V		[B]	2-pin ASS2	0.25 m
37-8007-167		-/-		24 V		[B]	2-pin ASS2	1.20 m
37-8007-197		1/-		24 V		[B]	2-pin ASS2	3.00 m
38-8007-137		1/-		24 V		[C]	2-pin ASS2	0.25 m
38-8007-147		-/-		24 V		[C]	2-pin ASS2	3.00 m
38-8007-157		-/-		24 V		[C]	2-pin ASS2	1.20 m

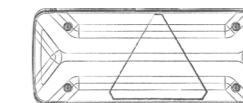

# LINEPOINT II LED

Three lamps – many options

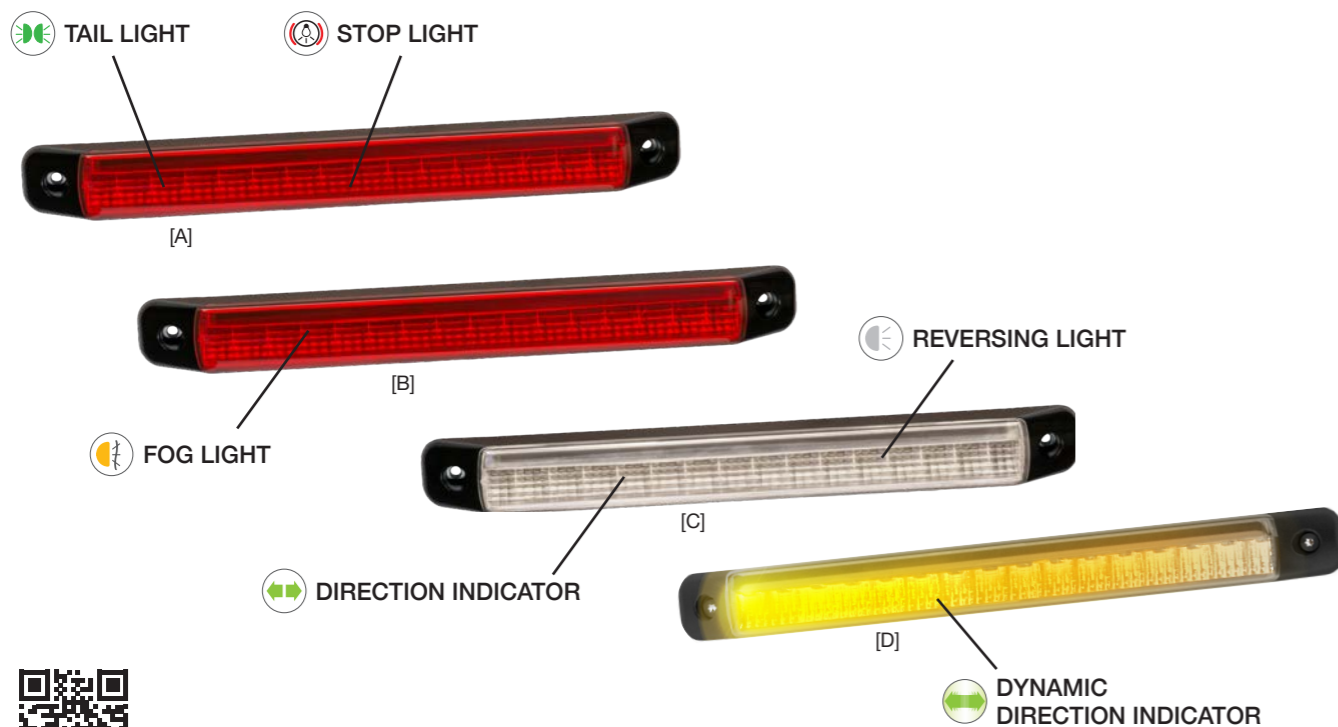

ADR Zone 2 IP6K9K



## PRODUCT FEATURES

### FULL LED

All functions in LED

### 360° MOUNTING POSITION

For direction indicator, fog and stop light as well as vehicle position lamp

### CAN BE COMBINED

Double mounting is possible

### HOMOGENEOUS LIGHT PATTERN

Thanks to modern reflector technology

### DYNAMIC DIRECTION INDICATOR

For mounting angle up to +/- 28°

### DUAL VOLTAGE

For 12 & 24 volt applications

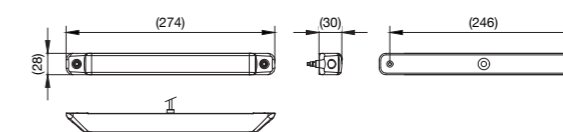

← PART NO.	→ PART NO.	☐	💡	⚡	VERSION	FUNCTIONS	ADDITION	CONNECTION	CABLE
31-9230-007		1/-	LED	12V 24V	[A]			Open end	0.50 m
37-9230-007		1/-	LED	12V 24V	[B]			Open end	0.50 m
31-9231-007		1/-	LED	12V 24V	[B]			Open end	0.50 m
38-9230-007		1/-	LED	12V 24V	[B]			Open end	0.50 m
38-9231-007		1/-	LED	12V 24V	[B]			Open end	0.50 m
31-9231-207	31-9231-217	1/-	LED	12V 24V	[C]			Open end	0.50 m

# LINEPOINT I LED

Three lamps – many options



1- or  
2-function light



3-function light

ADR  
Zone 2 IP6K9K

## PRODUCT FEATURES

### FULL LED

All functions in LED

### 90° MOUNTING POSITION

For direction indicator, rear fog and tail as well as stop light

### CAN BE COMBINED AS REQUIRED

All lamps can be combined according to your requirements

### DUAL VOLTAGE

For 12 & 24 volt applications

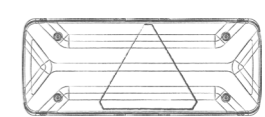

Mounting **VERTICAL**



Mounting **HORIZONTAL**

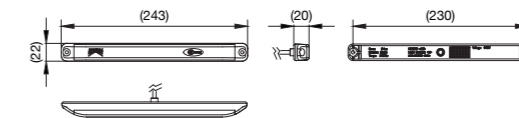

↔ PART NO.	☐	💡	⚡	VERSION	FUNCTIONS	ADDITION	CONNECTION	CABLE
31-9220-007	1/-	LED	12V 24V	[A]	🚗🛑	⬆️ ↔️	Open end	0.50 m
31-9221-007	1/-	LED	12V 24V	[B]	↔️	⬆️ ↔️	Open end	0.50 m
37-9220-007	1/-	LED	12V 24V	[A]	🌫️	⬆️ ↔️	Open end	0.50 m
38-9220-007	1/-	LED	12V 24V	[B]	🔄	⬆️ ↔️	Open end	0.50 m
31-8920-007	1/-	LED	12V 24V	[A]	🛑	↔️	Open end	0.50 m
33-8914-007	1/-	LED	12V 24V	[B]	🚗🛑↔️	⬆️ ↔️	Open end	0.50 m
33-8914-017	1/-	LED	12V 24V	[B]	🚗🛑↔️	⬆️ ↔️	Open end	5.00 m
31-9207-047	1/-	LED	12V 24V	[A]	🚗🛑	⬆️ ↔️	ASS3	0.50 m
31-9207-057	1/-	LED	12V 24V	[B]	↔️	⬆️ ↔️	ASS3	0.50 m
37-9207-017	1/-	LED	12V 24V	[A]	🌫️	⬆️ ↔️	ASS3	0.50 m
38-9207-017	1/-	LED	12V 24V	[B]	🔄	⬆️ ↔️	ASS3	0.50 m

# POSITION LAMPS

FLATPOINT II LED

**UNIPOINT II LED**

POSIPOINT II LED

**MONOPOINT II LED**

NUMBER PLATE LAMPS

BEACONS

INTERIOR LAMPS

**WORK LAMPS**

NUMBER PLATE HOLDERS

SIDE MARKER LAMPS

REVERSING LAMPS

E LIGHT

POSITIONS LAMPS

**OUTLINE MARKER LAMPS**

REAR LAMPS

NUMBER PLATE LAMPS

BEACONS

**ERIOR LAMPS**

LAMPS

NUMBER PLATE HOLDERS

Depending on the colour of the lens, Aspöck position lamps meet different requirements. They stand out above all due to their uniform design and many mounting options.

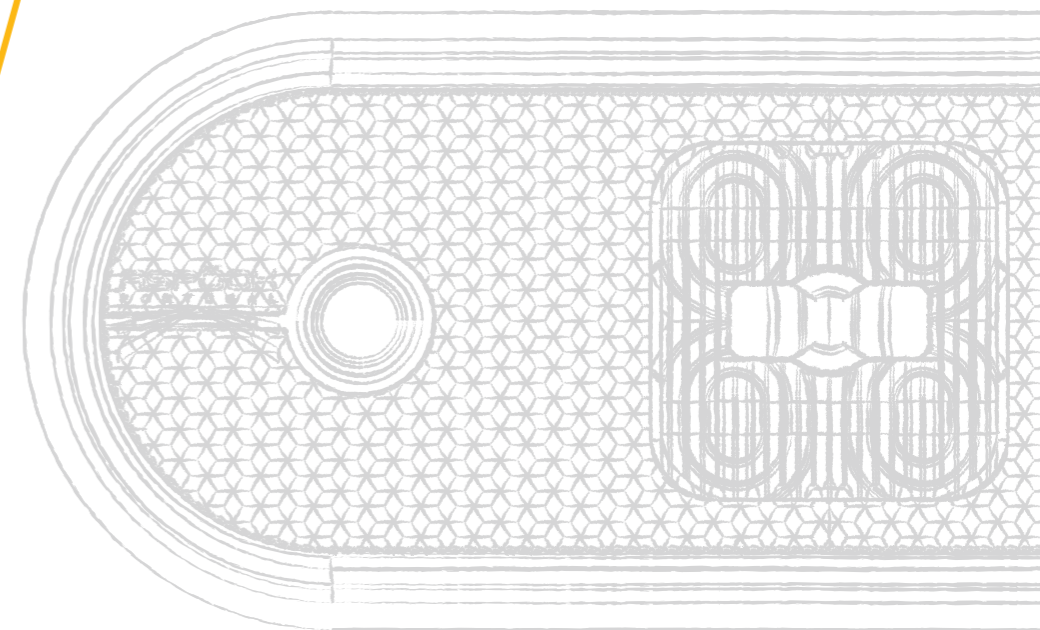

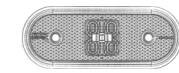

# FLATPOINT II LED

Impresses with versatile mounting options

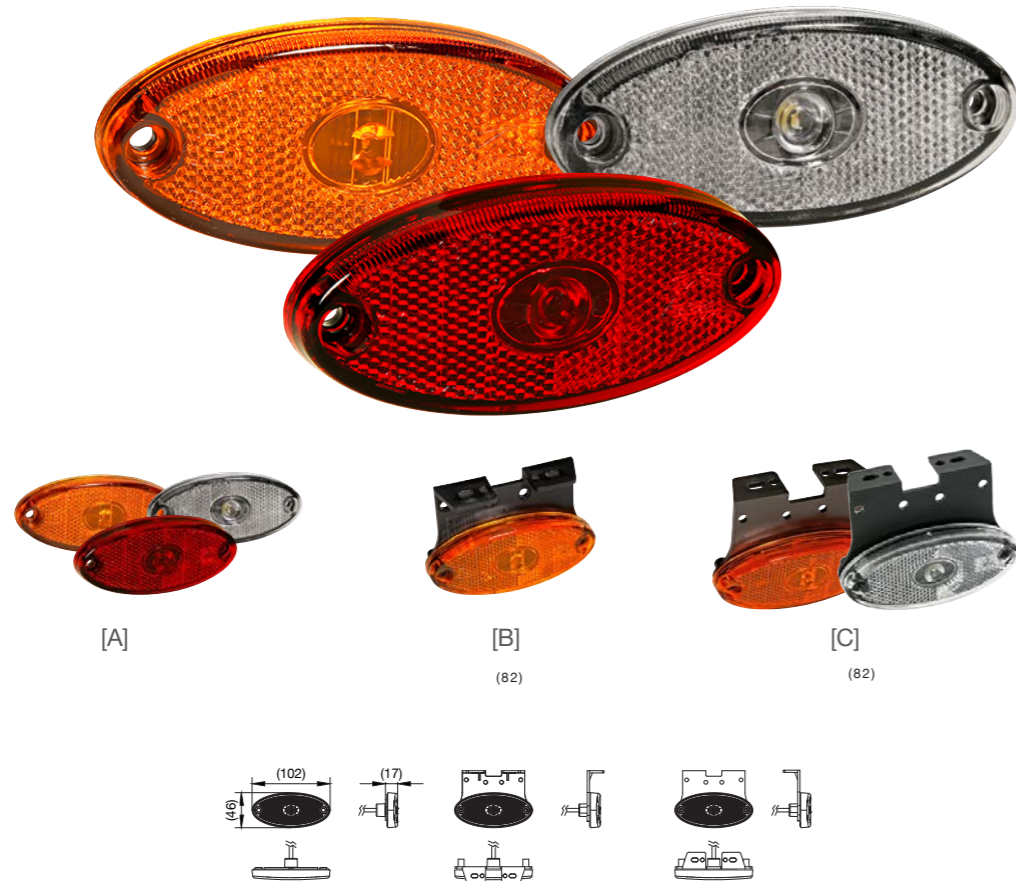

## PRODUCT FEATURES

### STURDY CONSTRUCTION

For a long service life

### COMPACT DESIGN

Thanks to flat lens & optionally integrated retro-reflector

### HIGHLY DIVERSE VARIANTS

Due to different cable lengths and plug connections

### OPTIONALLY AVAILABLE AS DUAL VOLTAGE

For 12 & 24 volt applications

PART NO.	Box	LED	V	VERSION	FUNCTION	CONNECTION	CABLE
31-2304-017	1/100	LED	24 V	[A]		P&R	0.50 m
31-2304-037	1/100	LED	24 V	[A]		P&R	1.50 m
31-2304-097	1/-	LED	12V 24V	[A]		P&R	1.50 m
31-2307-017	1/50	LED	24 V	[A]		ASS3	1.50 m
31-2364-017	1/100	LED	24 V	[B]		P&R	0.50 m
31-2364-037	1/60	LED	24 V	[B]		P&R	1.50 m
31-2367-057	1/-	LED	24 V	[B]		ASS3	1.50 m
31-2364-087	1/100	LED	24 V	[C]		P&R	0.50 m
31-2364-107	1/100	LED	24 V	[C]		P&R	1.50 m
31-2367-037	1/50	LED	24 V	[C]		ASS3	1.50 m
31-6900-017	1/-	LED	24 V	[A]		Open end	0.50 m
31-6904-017	1/100	LED	24 V	[A]		P&R	0.50 m
31-6907-027	1/100	LED	24 V	[A]		ASS3	0.50 m
31-6904-037	1/100	LED	24 V	[A]		P&R	1.50 m
31-6904-167	1/-	LED	12V 24 V	[A]		P&R	1.50 m
31-6907-037	1/50	LED	24 V	[A]		ASS3	1.50 m
31-6904-057	1/50	LED	24 V	[A]		P&R	3.50 m
31-6904-127	1/-	LED	24 V	[A]		P&R	3.50 m
31-6404-017	1/100	LED	24 V	[A]		P&R	0.50 m
31-6404-097	1/-	LED	24 V	[A]		P&R	0.50 m
31-6404-127	1/-	LED	24 V	[A]		P&R	3.50 m

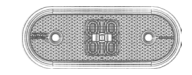

# UNIPOINT I LED

Extremely sturdy side marker lamps with LED technology



ADR Zone 2 IP 6K9K

## PRODUCT FEATURES

### HIGH LIGHT INTENSITY

With low power consumption

### SIMPLE MOUNTING

Made easy with many mounting options

### VERY STURDY DESIGN

Due to the over-moulded lens and the encapsulated printed circuit board

### HIGHLY DIVERSE VARIANTS

Due to different cable lengths and plug connections

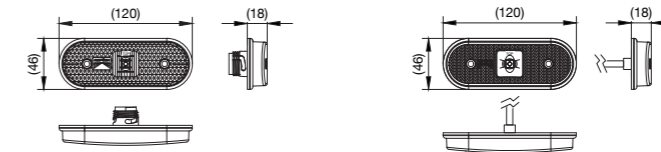

PART NO.				VERSION	FUNCTIONS	ADDITION	CONNECTION	CABLE
31-2004-017	1/100	LED	24 V	[A]			P&R	0.50 m
31-2007-237	1/-	LED	24 V	[A]			ASS3	0.50 m
31-2004-037	1/90	LED	24 V	[A]			P&R	1.50 m
31-2004-107	1/-	LED	24 V	[A]			P&R	1.50 m
31-2007-247	1/50	LED	24 V	[A]			ASS3	1.50 m
31-2064-017	1/60	LED	24 V	[B]			P&R	0.50 m
31-2067-097	1/100	LED	24 V	[B]			ASS3	0.50 m
31-2064-037	1/75	LED	24 V	[B]			P&R	1.50 m
31-2067-107	1/50	LED	24 V	[B]			ASS3	1.50 m
31-2064-717	1/90	LED	24 V	[C]			P&R	0.50 m
31-2064-737	1/75	LED	24 V	[C]			P&R	1.50 m
31-2064-217	1/90	LED	24 V	[D]			P&R	0.50 m
31-2064-237	1/60	LED	24 V	[D]			P&R	1.50 m
31-2064-417	1/50	LED	24 V	[E]			P&R	0.50 m
31-2064-437	1/50	LED	24 V	[E]			P&R	1.50 m



# UNIPOINT MAXX

Extremely sturdy side marker with LED technology

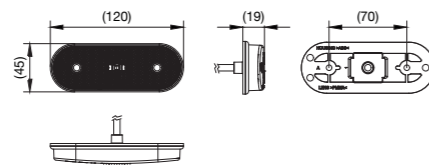

ADR Zone 2 IP 6K9K



## PRODUCT FEATURES

### INCREASED SAFETY

Better visibility along the vehicle

### HIGH LIGHT INTENSITY

Displaying the maximum allowed light intensity

### SIMPLE MOUNTING

Thanks to the specially designed brackets

### VERY STURDY DESIGN

Due to the over-moulded lens and the encapsulated printed circuit board

## UNIPOINT MAXX

PART NO.	Box	LED	V	FUNCTION	ADDITION	CONNECTION	CABLE
31-2104-067	1/-	LED	24 V	☀️	↔️	P&R	2.00 m

# UNIPOINT DI



The **ECE 48 Rev. 6 regulation** states that for vehicles of category O3 and O4, three additional category 5 side marker lamps must be fitted to the trailer as uniformly as possible, and must flash in synchronicity with the truck.

The aim is to significantly increase safety for all road users when turning.

The Unipoint DI directional indicator complies with this legislation. Alternatively, a SMCG can be installed in the vehicle. See description SMCG on page 102.



## PRODUCT FEATURES

### SPACE-SAVING SYSTEM INTEGRATION

Side marker lamp & cat. 5 blinker in one lamp

### IMPROVED PERCEPTION

Using far reaching beams

PART NO.	Box	LED	V	FUNCTION	ADDITION	CONNECTION	CABLE
31-2107-017	1/50	LED	24 V	☀️ ➡️		3-pin ASS3	1.50 m
31-2104-077	1/-	LED	24 V	↔️	↔️	P&R	1.50 m
31-2107-007	1/-	LED	24 V	↔️	↔️	ASS3	1.50 m

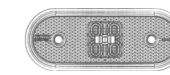

# UNIPOINT I LED

Powerful light output and construction



ADR Zone 2 IP 6K9K

## PRODUCT FEATURES

### HIGH LIGHT INTENSITY

With low power consumption

### VERY STURDY DESIGN

Due to the over-moulded lens and the encapsulated printed circuit board

### HIGHLY DIVERSE VARIANTS

Due to different cable lengths and plug connections

### COMPACT DESIGN

With optional retro-reflector integrated in the lamp

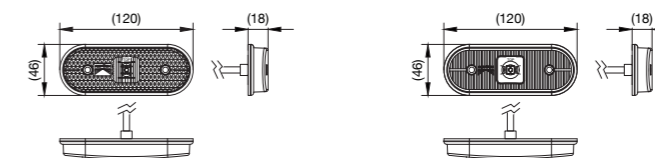

PART NO.	Box	Light	V	VERSION	FUNCTION	ADDITION	CONNECTION	CABLE
31-7704-017	1/100	LED	24 V	[A]			P&R	0.50 m
31-7704-097	1/-	LED	24 V	[B]			P&R	0.50 m
31-7707-107	1/50	LED	24 V	[A]			ASS3	0.50 m
31-7704-077	1/-	LED	24 V	[A]			P&R flat cables	1.00 m
31-7704-037	1/80	LED	24 V	[A]			P&R	1.50 m
31-7707-117	1/50	LED	24 V	[A]			ASS3	1.50 m
31-7704-227	1/50	LED	24 V	[A]			P&R	1.50 m
31-7704-057	1/60	LED	24 V	[A]			P&R	3.50 m
31-7704-127	1/-	LED	24 V	[B]			P&R	3.50 m
31-7707-127	1/-	LED	24 V	[B]			ASS3	3.50 m
31-7704-087	1/60	LED	24 V	[B]			P&R flat cables	4.00 m
31-7804-017	1/100	LED	24 V	[C]			P&R	0.50 m
31-7804-097	1/-	LED	24 V	[D]			P&R	0.50 m
31-7804-077	1/-	LED	24 V	[C]			P&R flat cables	1.00 m
31-7804-057	1/-	LED	24 V	[C]			P&R	3.50 m
31-7804-127	1/10	LED	24 V	[D]			P&R	3.50 m
31-7804-087	1/-	LED	24 V	[D]			P&R flat cables	4.00 m

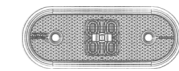

# POSIPOINT II LED

Simple, space-saving installation



ADR Zone 2 IP 6K9K

## PRODUCT FEATURES

### HIGH LIGHT OUTPUT

With low power consumption

### DIFFERENT MOUNTING OPTIONS

Direct installation on the vehicle or body by means of a bracket (housing)

### SLIM DESIGN

Space-saving mounting

### DUAL VOLTAGE

For 12 & 24 volt applications



PART NO.				FUNCTION	CONNECTION	CABLE
31-7100-067	1/-	LED	12V 24V		Open end	0.50 m
31-7104-007	1/-	LED	12V 24V		P&R	0.50 m
31-7104-017	1/130	LED	12V 24V		P&R	1.50 m
31-7104-027	1/70	LED	12V 24V		P&R	1.50 m
31-7100-017	1/-	LED	12V 24V		Open end	3.50 m
31-7100-007	1/-	LED	12V 24V		Open end	5.00 m
31-7200-067	1/50	LED	12V 24V		Open end	0.50 m
31-7204-007	1/100	LED	12V 24V		P&R	0.50 m
31-7204-017	1/-	LED	12V 24V		P&R	1.50 m
31-7204-027	1/-	LED	12V 24V		P&R	1.50 m
31-7200-017	1/70	LED	12V 24V		Open end	3.50 m
31-7200-007	1/-	LED	12V 24V		Open end	3.50 m

## Accessory

PART NO.		
15-5609-107	1/-	Housing

# MONOPOINT II LED

The quick solution without any screws

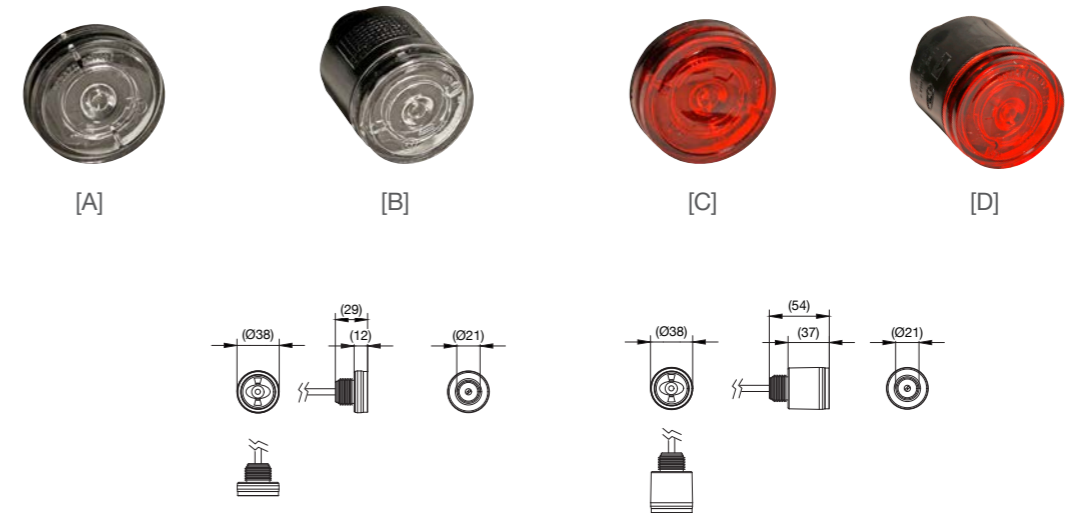

ADR Zone 2 IP 6K9K

## PRODUCT FEATURES

### SIMPLE MOUNTING

No screws, thanks to special rubber ribs

### HIGH LIGHT OUTPUT

With low power consumption

### SLIM DESIGN

Space-saving mounting

PART NO.				VERSION	FUNCTION	CONNECTION	CABLE
31-6704-067	1/100	LED	12V 24 V	[A]		P&R	0.50 m
31-6704-077	1/-	LED	12V 24 V	[A]		P&R	1.50 m
31-6704-087	1/-	LED	12V 24 V	[A]		P&R	3.50 m
31-6700-027	1/20	LED	12V 24 V	[A]		Open end	3.50 m
31-6704-097	1/-	LED	12V 24 V	[B]		P&R	0.50 m
31-6704-107	1/-	LED	12V 24 V	[B]		P&R	1.50 m
31-6704-117	1/-	LED	12V 24 V	[B]		P&R	3.50 m
31-6700-037	1/20	LED	12V 24 V	[B]		Open end	3.50 m
31-6804-087	1/-	LED	12V 24 V	[C]		P&R	0.50 m
31-6804-067	1/-	LED	12V 24 V	[C]		P&R	3.50 m
31-6804-097	1/-	LED	12V 24 V	[C]		P&R cable	5.00 m
31-6800-017	1/-	LED	12V 24 V	[C]		Open end	3.50 m
31-6804-077	1/-	LED	12V 24 V	[D]		P&R	3.50 m

# END-OUTLINE MARKER LAMPS

FLEXPOINT I LED

**SUPERPOINT IV LED**

SUPERPOINT III LED

SUPERPOINT II

NUMBER PLATE LAMPS

BEACONS

INTERIOR LAMPS

**WORK LAMPS**

NUMBER PLATE HOLDERS

SIDE MARKER LAMPS

REVERSING LAMPS

E LIGHT

POSITIONS LAMPS

**OUTLINE MARKER LAMPS**

REAR LAMPS

NUMBER PLATE LAMPS

BEACONS

**ERIOR LAMPS**

LAMPS

NUMBER PLATE HOLDERS

Multiple mounting options are one of the many product features that the end-outline marker lamps from Aspöck Systems have to offer. These lamps also increase the safety of your vehicle due to their high visibility.

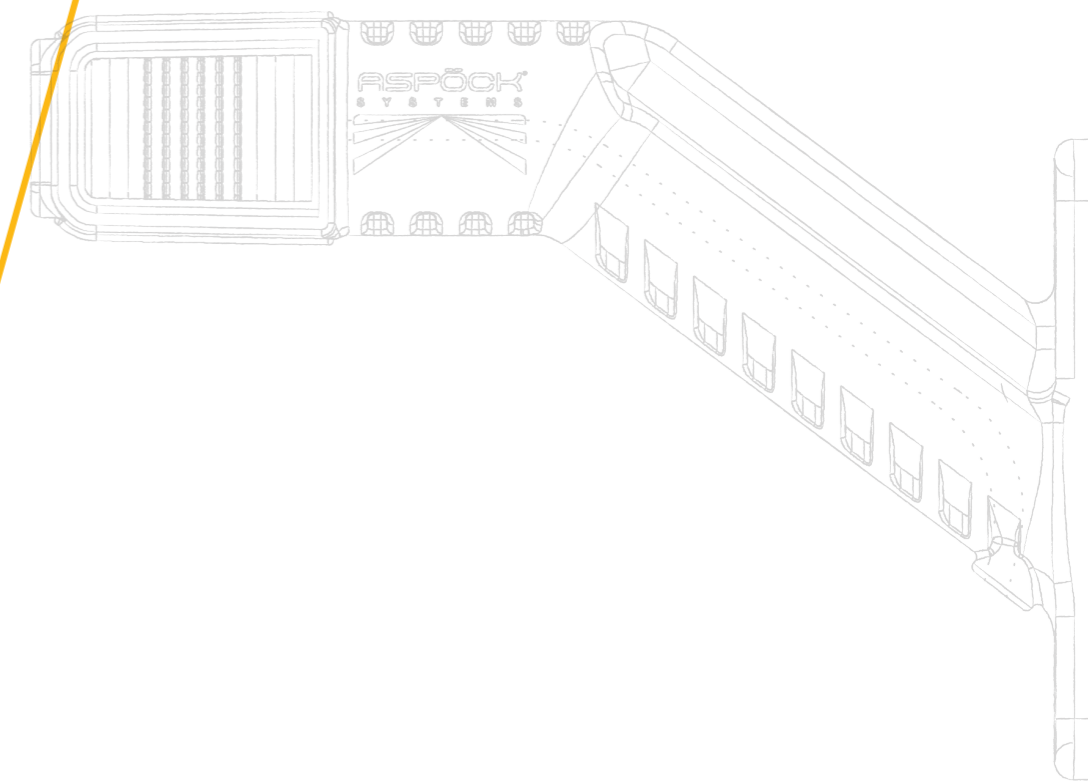

# SUPERPOINT IV LED

Universal application across different versions



## PRODUCT FEATURES

### RESISTANT DESIGN

Flexible mounting arm in different versions

### HIGH LIGHT OUTPUT

With low power consumption

### LED END-OUTLINE MARKER LAMP

With a clear design

### HIGHLY DIVERSE VARIANTS

Due to different brackets, cable lengths and plug connections

### INCLUDING SIDE MARKER LAMP

Either in orange or red

### DUAL VOLTAGE

For 12 & 24 volt applications

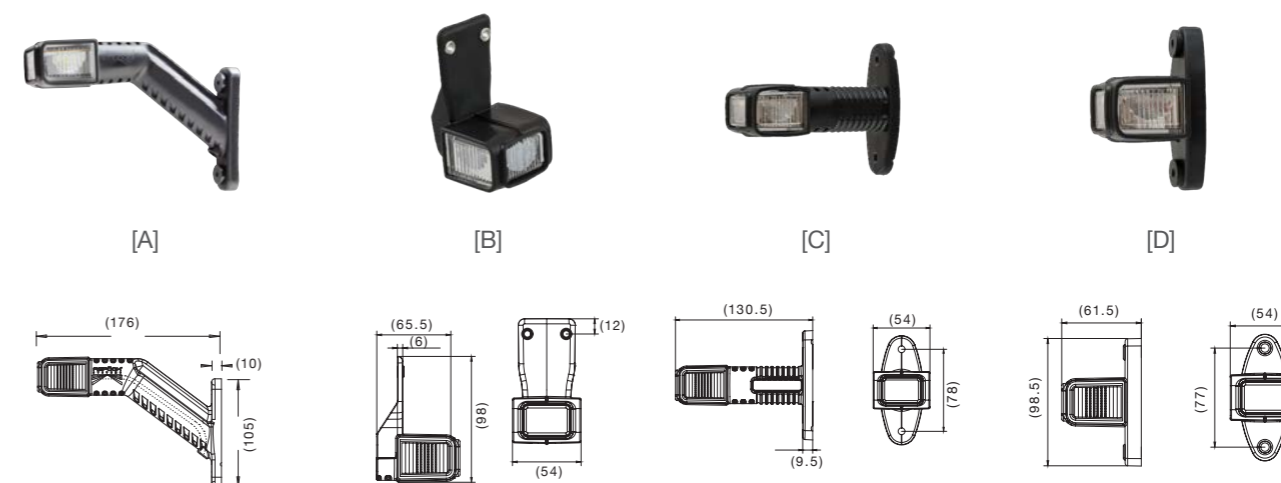

← PART NO.	→ PART NO.	📦	💡	⚡ V	VERSION	ADDITION	CONNECTION	CABLE
31-3104-007	31-3104-017	1/50	LED	12V 24 V	[A]		P&R	2.00 m
31-3105-017	31-3106-017	1/50	LED	12V 24 V	[A]		ASS2	0.50 m
31-3105-007	31-3106-007	1/50	LED	12V 24 V	[A]		ASS2	2.00 m
31-3104-087	31-3104-097	1/-	LED	12V 24 V	[B]		P&R	2.00 m
31-3104-047	31-3104-057	1/-	LED	12V 24 V	[C]		P&R	2.00 m
31-3104-067	31-3104-077	1/-	LED	12V 24 V	[D]		P&R	2.00 m

# SUPERPOINT III LED

Powerful form and light performance



## PRODUCT FEATURES

### MANY MOUNTING OPTIONS

Due to a large selection of brackets

### HIGH LIGHT OUTPUT

With low power consumption

### SAME ITEM CAN BE USED ON BOTH SIDES

For bracket version [B] and [D]

### DURABLE DESIGN

Break-proof, weather-resistant and flexible material

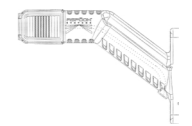

[A]

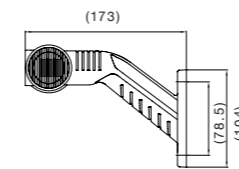

[B]

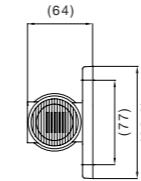

[C]

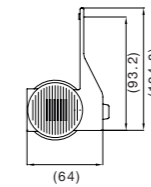

[D]

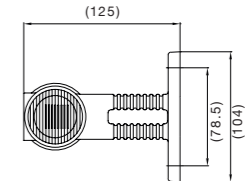

← PART NO.	→ PART NO.	☐	💡	⚡	VERSION	ADDITION	CONNECTION	CABLE
31-3304-047	31-3304-057	1/50	LED	24 V	[A]	🇩🇪	P&R	1.25 m
31-3304-067	31-3304-077	1/-	LED	24 V	[A]	🇩🇪	P&R	1.25 m
31-3305-127	31-3306-127	1/-	LED	24 V	[A]	🇩🇪	ASS3	1.25 m
31-3305-017	31-3306-017	1/-	LED	24 V	[A]	🇩🇪	ASS2	1.75 m
31-3303-007	31-3302-007	1/25	LED	24 V	[A]	🇩🇪	Open end	4.00 m
31-3303-017	31-3302-017	1/-	LED	24 V	[A]	🇩🇪	Open end	4.00 m
31-3364-007		1/50	LED	24 V	[B]	🇩🇪	P&R	1.50 m
31-3360-007		1/25	LED	24 V	[B]	🇩🇪	Open end	4.00 m
31-3364-017		1/-	LED	24 V	[B]	🇩🇪	P&R	1.50 m
31-3360-017		1/-	LED	24 V	[B]	🇩🇪	Open end	4.00 m
31-3364-057	31-3364-027	1/50	LED	24 V	[C]	🇩🇪	P&R	1.50 m
31-3365-017	31-3366-027	1/-	LED	24 V	[C]	🇩🇪	Open end	4.00 m
31-3364-047	31-3364-037	1/-	LED	24 V	[C]	🇩🇪	P&R	1.50 m
31-3365-027	31-3366-017	1/-	LED	24 V	[C]	🇩🇪	Open end	4.00 m
31-3304-087		1/-	LED	24 V	[D]	🇩🇪	P&R	1.25 m
31-3307-017		1/50	LED	24 V	[D]	🇩🇪	ASS2	1.75 m
31-3307-007		1/-	LED	24 V	[D]	🇩🇪	ASS2	1.75 m
31-3300-247		1/40	LED	24 V	[D]	🇩🇪	Open end	4.00 m

# NUMBER PLATE LAMPS

**FLEXLED**

**REGPOINT II LED**

REGPOINT I LED

REGPOINT I

NUMBER PLATE LAMPS

BEACONS

INTERIOR LAMPS

**WORK LAMPS**

NUMBER PLATE HOLDERS

SIDE MARKER LAMPS

REVERSING LAMPS

E LIGHT

POSITIONS LAMPS

**OUTLINE MARKER LAMPS**

REAR LAMPS

NUMBER PLATE LAMPS

BEACONS

**ERIOR LAMPS**

LAMPS

NUMBER PLATE HOLDERS

For the best possible illumination of a number plate, Aspöck offers a range of number plate lights with different designs and various connections.

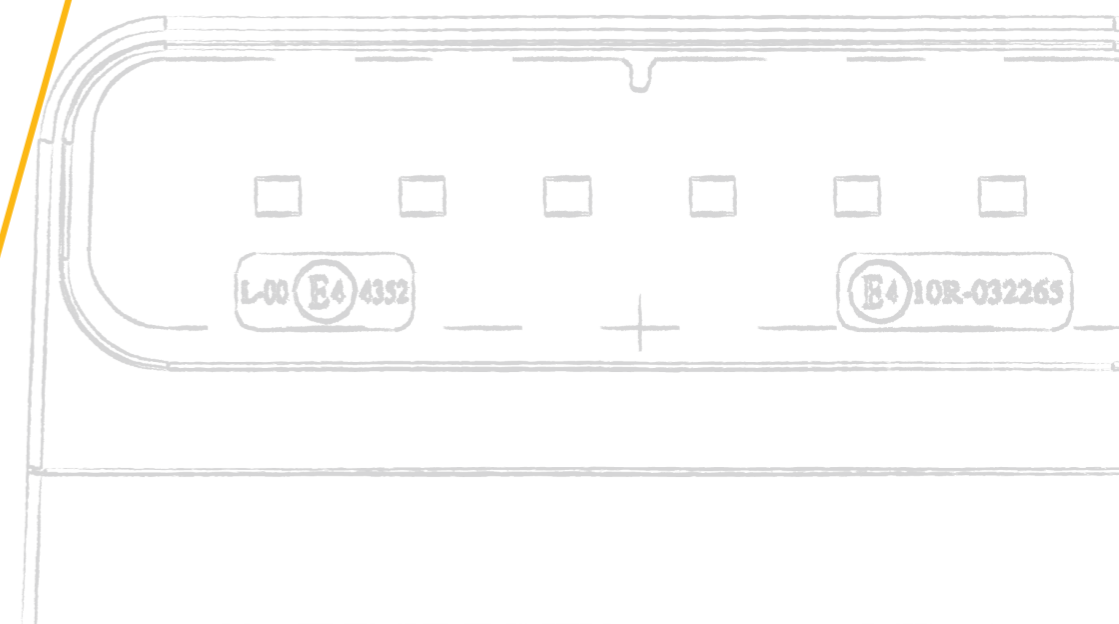



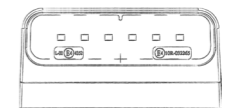

# REGPOINT II LED

Two designs for maximum flexibility



Version SINGLE MOUNTING

Version DOUBLE MOUNTING



[A]



[B]

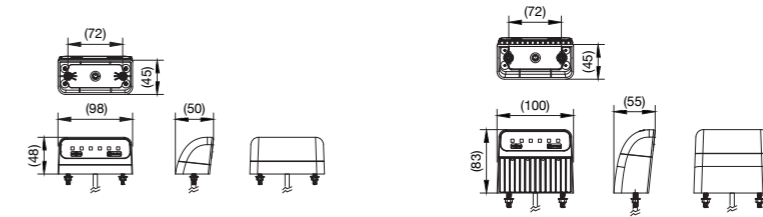

## PRODUCT FEATURES

### SIMPLE MOUNTING

Thanks to installed bolts

### HIGHLY DIVERSE VARIANTS

Due to different cable lengths and plug connections

### HIGH LIGHT OUTPUT

With low power consumption

### SINGLE MOUNTING POSSIBLE

Through use of the raised version with base

### DUAL VOLTAGE

For 12 & 24 volt applications

PART NO.				VERSION	MOUNTING	CONNECTION	CABLE
36-3804-007	1/100	LED	12V 24V	[A]		P&R	0.50 m
36-3804-017	1/50	LED	12V 24V	[A]		P&R	2.00 m
36-3806-007	1/50	LED	12V 24V	[A]		ASS2	0.50 m
36-3805-007	1/25	LED	12V 24V	[A]		ASS2	2.00 m
36-3810-007	1/50	LED	12V 24V	[A]		ASS3	0.50 m
36-3864-007	1/-	LED	12V 24V	[B]		P&R	0.50 m
36-3864-017	1/50	LED	12V 24V	[B]		P&R	2.00 m
36-3867-017	1/-	LED	12V 24V	[B]		ASS2	0.50 m
36-3867-027	1/50	LED	12V 24V	[B]		ASS2	2.00 m
36-3865-007	1/-	LED	12V 24V	[B]		ASS3	0.50 m

# REGPOINT I & REGPOINT I LED

A wide range with practical application



Version **LED**



Version **LIGHT BULB**

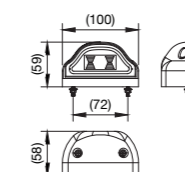

ADR Zone 2 IP54

## PRODUCT FEATURES

### SIMPLE MOUNTING

Thanks to installed bolts

### HIGHLY DIVERSE VARIANTS

Due to different cable lengths and plug connections

### HIGH LIGHT OUTPUT FOR LED

With low power consumption

PART NO.				MOUNTING	CONNECTION	CABLE
36-3604-007	1/-	<b>LED</b>	24 V		P&R	0.50 m
36-3604-017	1/80	<b>LED</b>	24 V		P&R	1.00 m
36-3604-027	1/40	<b>LED</b>	24 V		P&R	3.50 m
36-3607-007	1/-	<b>LED</b>	24 V		ASS2	0.50 m
36-3607-017	1/50	<b>LED</b>	24 V		ASS2	1.00 m
36-3607-027	1/40	<b>LED</b>	24 V		ASS2	3.50 m
36-3004-017	1/100		24 V		P&R	0.50 m
36-3004-027	1/100		24 V		P&R	1.00 m
36-3004-057	1/-		24 V		P&R	3.50 m
36-3007-007	1/90		24 V		ASS2	0.50 m
36-3007-057	1/50		24 V		ASS2	1.00 m
36-3007-047	1/20		24 V		ASS2	2.50 m
36-3007-397	1/90		24 V		ASS3	0.50 m

# FLEXLED NUMBER PLATE HOLDER

Innovative quick mounting and locking system

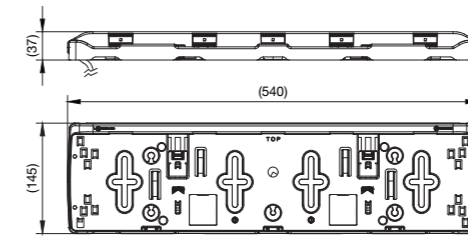

Mounting clip



## PRODUCT FEATURES

### LOCKING SYSTEM WITH QUICK CLAMPING

Quick and easy number plate change

### SMART QUICK-MOUNTING SYSTEM

Simple mounting of the holder on the vehicle

### FOR ALL EU NUMBER PLATES

Suitable for 110 and 120 mm height

### ADR-APPROVED

Tested for zone 2

### HOMOGENEOUS ILLUMINATION

Thanks to integrated FlexLED strip

PART NO.				CONNECTION	CABLE
36-3704-107	1/-	LED	24 V	Open end	0.50 m
36-3704-197	1/-	LED	24 V	Open end	1.50 m
36-3704-147	1/-	LED	24 V	P&R	0.50 m
36-3704-117	1/-	LED	24 V	P&R	1.50 m
36-3704-137	1/-	LED	24 V	ASS2	0.50 m
36-3704-177	1/-	LED	24 V	ASS2	1.50 m
36-3704-157	1/-	LED	24 V	Superseal	0.50 m
36-3704-187	1/-	LED	24 V	Superseal	1.50 m

## ACCESSORY

PART NO.		DESCRIPTION
15-5300-427	1/100	Mounting clip

# WORK & REVERSING LAMPS

WORKPOINT II 1000

**WORKPOINT II 1500**

WORKPOINT II 3000

NUMBER PLATE LAMPS

BEACONS

INTERIOR LAMPS

**WORK LAMPS**

NUMBER PLATE HOLDERS

SIDE MARKER LAMPS

REVERSING LAMPS

E LIGHT

POSITIONS LAMPS

**OUTLINE MARKER LAMPS**

REAR LAMPS

NUMBER PLATE LAMPS

BEACONS

**ERIOR LAMPS**

LAMPS

NUMBER PLATE HOLDERS

Working in the dark or in poor lighting conditions often demands a lot from you. These specially developed work lamps provide a reliable light source and ensure optimum light distribution during the day and at night.

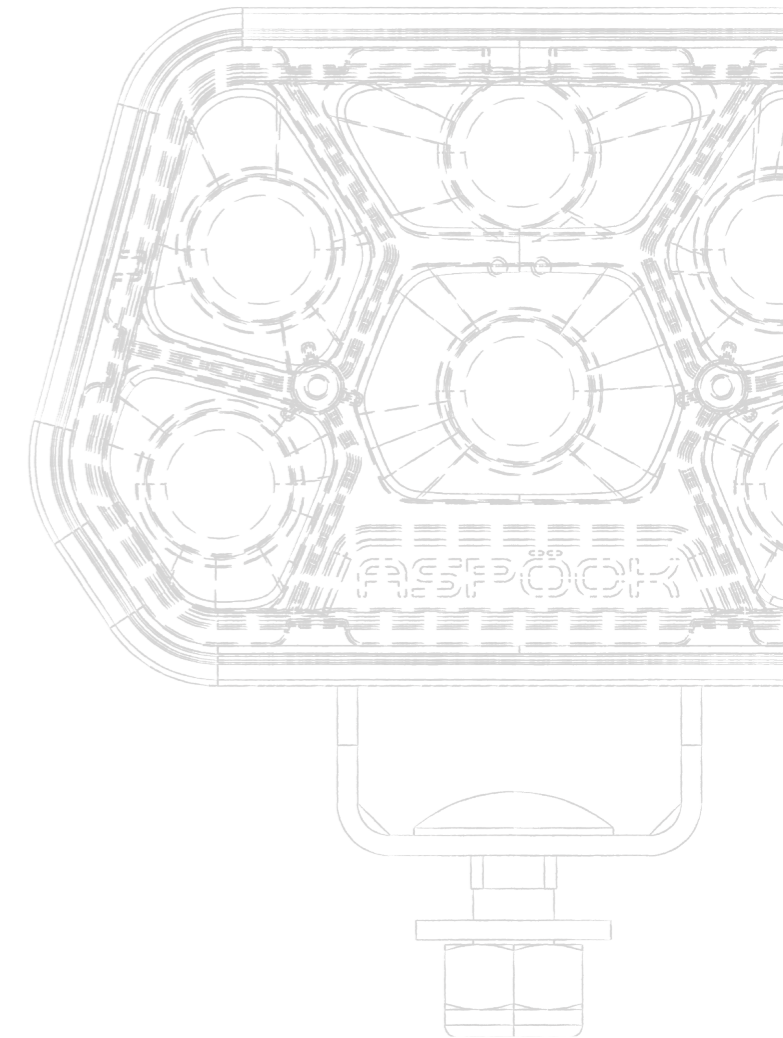

# WORKPOINT II 3000

LED work lamp & reversing light with large adjustment angle



## PRODUCT FEATURES

### HIGH EFFICIENCY

Due to >95 lumens/watt

### LARGE VERTICAL SWIVEL RANGE

From -67° to +127°

### LIGHT AND COMPACT

A weight of only 660 grams

### LIGHT COLOUR SIMILAR TO DAYLIGHT

5700 Kelvin

### HOMOLOGATED REVERSING LIGHT

According to ECE R23

### EXCELLENT CORROSION RESISTANCE

Powder-coated aluminium heat sink

### OPTIMAL LIGHT DISTRIBUTION

With innovative optics

### HIGH-QUALITY MATERIALS

Bracket and screws are made of stainless steel

### DUAL VOLTAGE

For 12 & 24 volt applications

Can be swivelled up to +127°



Can be swivelled up to -67°

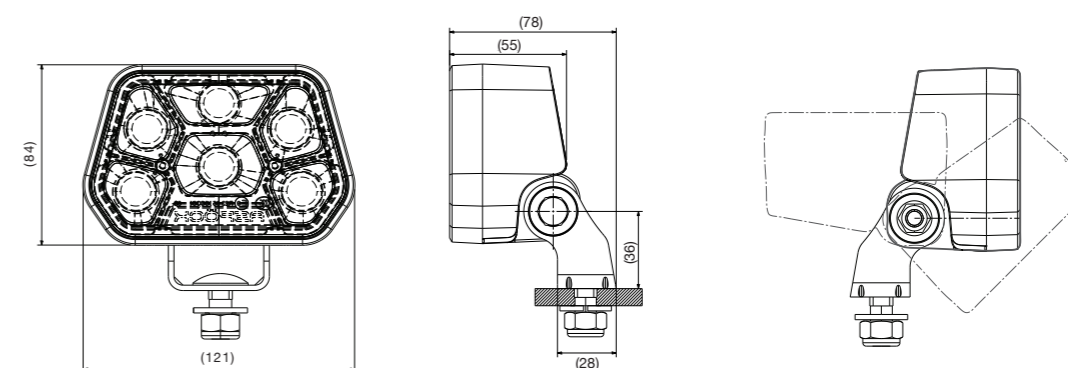

PART NO.				DESCRIPTION	LUMEN	CONNECTION	CABLE
28-8524-037	1/16	LED	12V 24 V	20° beam angle	3000	DT on housing	-
28-8524-047	1/16	LED	12V 24 V	60° beam angle	3000	DT on housing	-
38-8524-037	1/16	LED	12V 24 V	20° beam angle	3000	Open end	1.50 m
38-8524-047	1/16	LED	12V 24 V	60° beam angle	3000	Open end	1.50 m

## ACCESSORY

PART NO.		DESCRIPTION	CONNECTION
14-4302-227	1/-	Omega bracket	
69-0236-017	1/-	Extension for DT version	3.00 m open end
69-0236-007	1/-	Extension for DT version	5.00 m open end

# WORKPOINT II 1500

Compact LED work & reversing light with high efficiency

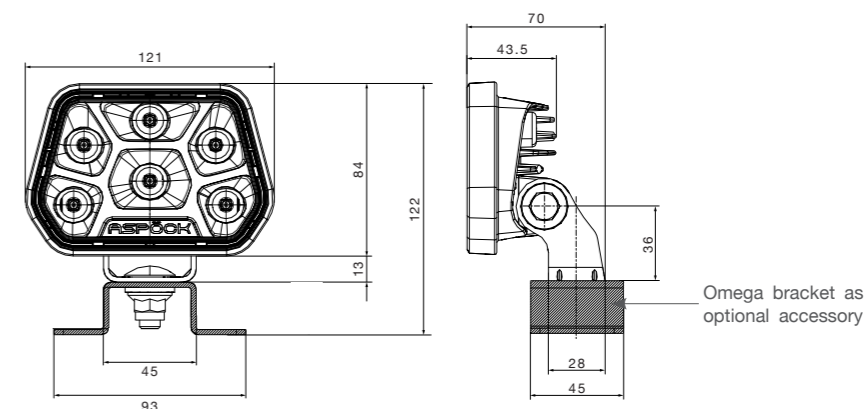

## PRODUCT FEATURES

### HIGH EFFICIENCY

Due to >125 lumens/watt

### LARGE VERTICAL SWIVEL RANGE

From -35° to +100°

### LIGHT AND COMPACT

A weight of only 560 grams

### LIGHT COLOUR SIMILAR TO DAYLIGHT

5700 Kelvin

### HOMOLOGATED REVERSING LIGHT

According to ECE R23

### EXCELLENT CORROSION RESISTANCE

Powder-coated aluminium heat sink

### OPTIMAL LIGHT DISTRIBUTION

With innovative optics

### HIGH-QUALITY MATERIALS

Bracket and screws are made of stainless steel

### DUAL VOLTAGE

For 12 & 24 volt applications

PART NO.			V	DESCRIPTION	LUMEN	CONNECTION	CABLE
28-8524-007	1/24	LED	12V 24 V	60° beam angle	1500	DT on housing	-
38-8524-007	1/24	LED	12V 24 V	60° beam angle	1500	Open end	1.50 m
38-8524-057	1/24	LED	12V 24 V	60° beam angle	1500	ASS2	1.50 m

## ACCESSORY

PART NO.		DESCRIPTION	CONNECTION
14-4302-227	1/-	Omega bracket	
69-0236-017	1/-	Extension for DT version	3.00 m open end
69-0236-007	1/-	Extension for DT version	5.00 m open end

# WORKPOINT II 1000

Compact design, flexible use



## PRODUCT FEATURES

### HIGH EFFICIENCY

Due to >100 lumens/watt

### LARGE VERTICAL SWIVEL RANGE

From -40° to +110°

### LIGHT COLOUR SIMILAR TO DAYLIGHT

5700 Kelvin

### LIGHT AND COMPACT

A weight of only 412 grams

### HOMOLOGATED REVERSING LIGHT

According to ECE R23

### CORROSION RESISTANT & HEAT DISSIPATING

Due to thermally conductive plastic

### OPTIMAL LIGHT DISTRIBUTION

With innovative optics

### HIGH-QUALITY MATERIALS

Bracket and screws are made of stainless steel

### DUAL VOLTAGE

For 12 & 24 volt applications

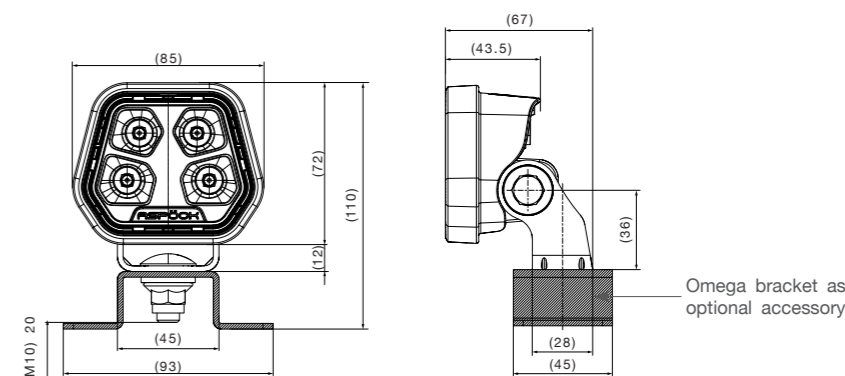

PART NO.				DESCRIPTION	LUMEN	CONNECTION	CABLE
28-8524-017	1/24	LED	12V 24 V	60° beam angle	1000	DT on housing	-
38-8524-017	1/24	LED	12V 24 V	60° beam angle	1000	Open end	1.50 m
38-8524-067	1/24	LED	12V 24 V	60° beam angle	1000	ASS2	1.50 m

## ACCESSORY

PART NO.		DESCRIPTION	CONNECTION
14-4302-227	1/-	Omega bracket	
69-0236-017	1/-	Extension for DT version	3.00 m open end
69-0236-007	1/-	Extension for DT version	5.00 m open end

# FLEXLED STRIPS & INTERIOR LAMPS

## FLEXLED

INPOINT III LED

NUMBER PLATE LAMPS

BEACONS

INTERIOR LAMPS

WORK LAMPS

NUMBER PLATE HOLDERS

SIDE MARKER LAMPS

REVERSING LAMPS

E LIGHT

POSITIONS LAMPS

OUTLINE MARKER LAMPS

REAR LAMPS

NUMBER PLATE LAMPS

BEACONS

INTERIOR LAMPS

LAMPS

NUMBER PLATE HOLDERS

Nowadays, it is not only the vehicle lighting on the outside that plays a crucial role. Interior lighting is also becoming increasingly important. Aspöck Systems offers an individual combination of design and functionality.

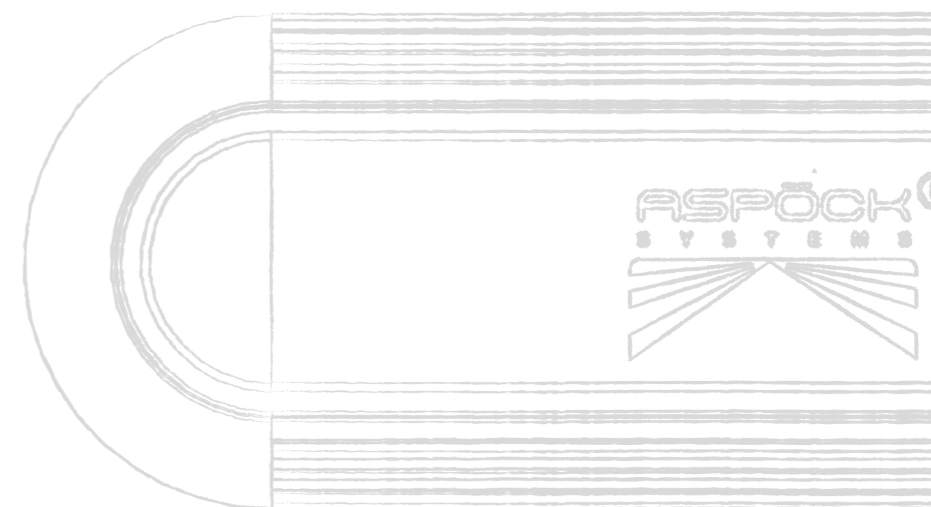



# ASPÖCK FLEXLED LED STRIPS

## FlexLED – light strips with a design factor

Future-proof LED technology merged with sleek design - when it comes to innovative vehicle lighting, appearance plays an important role alongside safety. Aspöck FlexLED has picked up on this trend and combined it with a system solution. Whether in the passenger compartment or in the loading area, Aspöck Systems offers you the perfect solution for your vehicle.

The LED strips are divided into the following categories and are available in the respective sizes depending on the category:

FlexLED Kelvin



Work and ambient lighting

FlexLED ECE



Rear light, 3rd brake light, position lamp

FlexLED Monochrome



Status display and special lighting

FlexLED small



FlexLED medium



FlexLED large



## CHARACTERISTICS

**IP6K9K**

Protection classification

**ECE R10**

Electromagnetic compatibility

**CISPR class3**

**ADR**

ADR-capable

**Can be homologated**

**51g shock**

Shock and vibration-resistant

**10-2000Hz vibration**

**Resistant to chemicals**

# FLEXLED KELVIN

LED strips, ideal for work and ambient lighting



## PRODUCT FEATURES

### USE: WORK & AMBIENT LIGHTING

Optimised light distribution ensures reduced shadows in working areas

### GLARE-FREE LIGHT SOURCE

Due to the linear light emission

### INTEGRATION IN VEHICLE STRUCTURAL COMPONENTS

Perfect illumination for the interior and exterior of the vehicle

### LIGHT COLOUR: WARM WHITE TO COLD WHITE

2700 Kelvin to 6000 kelvin

### DIFFERENT LIGHT OUTPUTS

From 270 lumens/m to 1500 lumens/m

### STURDY DESIGN

Vibration, shock and chemical resistant

### CASTING TRANSPARENT OR DIFFUSE

Depending on the area of application and requirement

# ECE LIGHT FUNCTIONS

Approved in line with ECE REG 48



Side marker lamp for truck trailers



Position lamp for truck trailers



3rd stop lamp and position lamps for truck trailers



## PRODUCT FEATURES

### AVAILABLE IN LARGE PROFILE

For homogeneous light emission and elegant cold design

### STURDY DESIGN

Vibration, shock and chemical resistant

### CUSTOMISED SOLUTIONS

Customised lengths for every lighting function

### AVAILABLE IN ALL ECE COLOURS

Red, yellow, white

# FLEXLED MONOCHROME

LED strips, ideal for status and special lighting

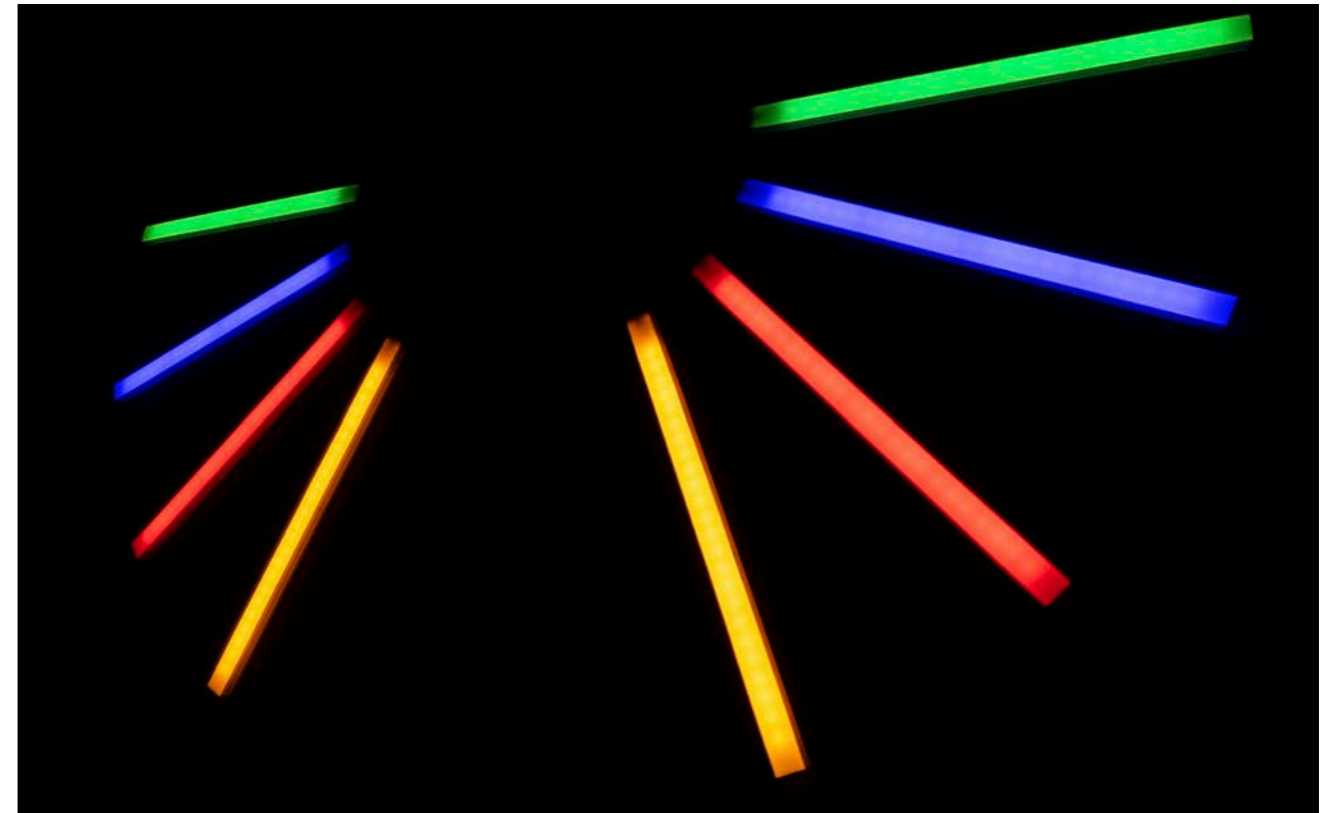

## PRODUCT FEATURES

### HIGH LIGHT PERFORMANCE

Using single-colour LEDs

### POWERFUL STATUS DISPLAYS

Thanks to freely selectable colour combinations

### AVAILABLE IN SMALL, MEDIUM AND LARGE

Enables universal use

# PRODUCT VERSIONS

The LED strips are available in the following sizes, depending on the product category



## FLEXLED SMALL

For a length up to 15 m  
Compact & space-saving  
Small bend radius of 10 cm

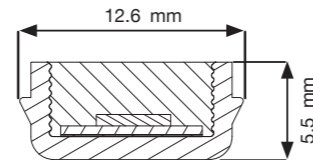

## FLEXLED MEDIUM

Can be used with profiles  
The multi purpose LED strip  
Small bend radius of 15 cm  
For a length up to 5 m

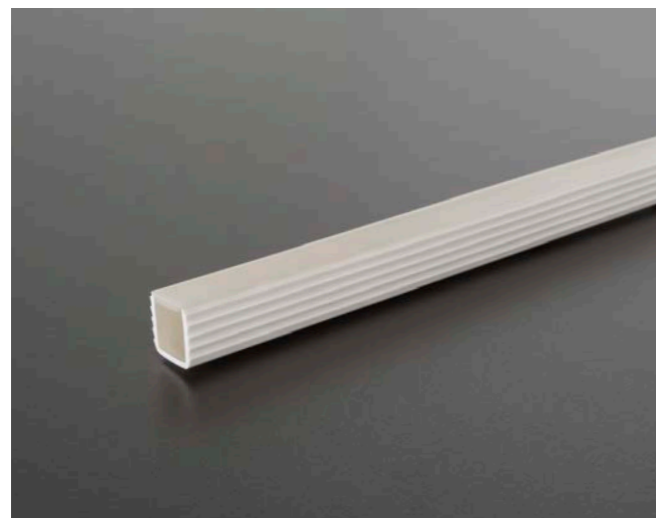
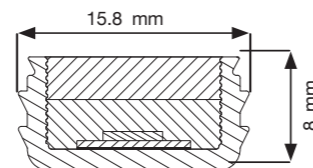

## FLEXLED LARGE

Designed for homologisable lighting functions  
Diffuse casting for homogeneous light emission  
Sturdy design  
For a length up to 5 m  
Small bend radius of 20 cm

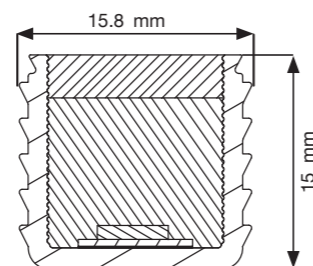

# FLEXLED PROFILE

Easy attachment due to medium mounting profiles



Interior lighting for truck trailers / mounting with corner profile

45° corner profile

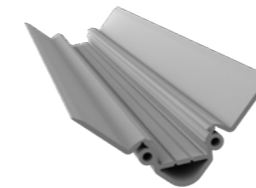

Ramp profile

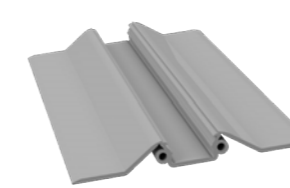

Flat profile

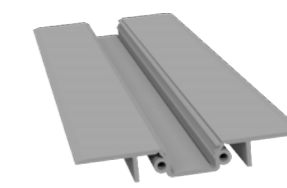

End cover

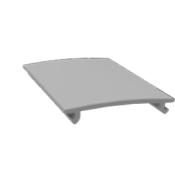

PART NO.	DESCRIPTION	COLOUR	LENGTH
14-4230-677	Mounting bracket corner profile medium	Grey RAL 7035	1.00 m
14-4130-647	Mounting bracket corner profile medium	Black RAL 9005	1.00 m
14-4230-657	Mounting bracket ramp profile medium	Grey RAL 7035	1.00 m
14-4230-627	Mounting bracket ramp profile medium	Black RAL 9005	1.00 m
14-4230-667	Mounting bracket flat profile medium	Grey RAL 7035	1.00 m
14-4230-637	Mounting bracket flat profile medium	Black RAL 9005	1.00 m
15-5250-737	LED strip cover	Transparent	1.00 m
15-5250-747	LED strip cover	Diffuse	1.00 m
15-5250-757	LED strip blind zone end cover	Grey RAL 7035	1.00 m
15-5250-767	LED strip blind zone end cover	Black RAL 9005	1.00 m

# INPOINT III LED

The optimum interior light for multiple applications

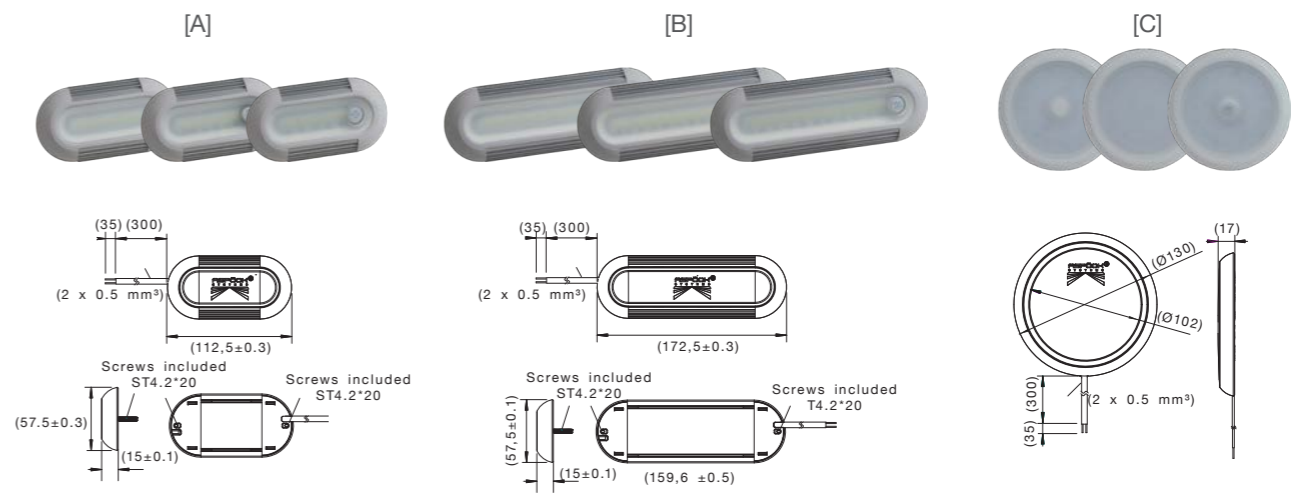

## PRODUCT FEATURES

### LONG LIFE SPAN

Thanks to sturdy construction

### OPTIMAL WORK LIGHT

Light colour 6000 kelvin

### HIGH LIGHT OUTPUT

With low power consumption

### THREE VERSIONS

Optionally with switch or motion sensor

### DUAL VOLTAGE

For 12 & 24 volt applications

### MODERN LOOK

Lens in frosted optics

PART NO.				VERSION	ADDITION	LUMEN	CONNECTION	CABLE
39-8900-157	1/-	LED	12V 24V	[A]	IP6K9K	700 lumens	Open end	0.30 m
39-8900-207	1/-	LED	12V 24V	[A] with motion sensor	IP67	700 lumens	Open end	0.30 m
39-8900-257	1/-	LED	12V 24V	[A] with switch	IP6K9K	700 lumens	Open end	0.30 m
39-8900-007	1/-	LED	12V 24V	[B]	IP6K9K	1,400 lumens	Open end	0.30 m
39-8900-057	1/-	LED	12V 24V	[B] with motion sensor	IP67	1,400 lumens	Open end	0.30 m
39-8900-107	1/-	LED	12V 24V	[B] with switch	IP6K9K	1,400 lumens	Open end	0.30 m
39-8900-307	1/-	LED	12V 24V	[C]	IP6K9K	2,200 lumens	Open end	0.30 m
39-8900-357	1/-	LED	12V 24V	[C] with motion sensor	IP67	2,200 lumens	Open end	0.30 m
39-8900-401	1/-	LED	12V 24V	[C] with switch	IP6K9K	2,200 lumens	Open end	0.30 m

# WIRING & JUNCTION BOXES

SML FEED LINE

DISTRIBUTOR XL

ASS DISTRIBUTOR

**MAIN CABLES**

P&R FLAT CABLES

FEED LINES

**SOCKET DISTRIBUTORS**

NUMBER PLATE LAMPS

BEACONS

INTERIOR LAMPS

**WORK LAMPS**

NUMBER PLATE HOLDERS

SIDE MARKER LAMPS

REVERSING LAMPS

E LIGHT

POSITIONS LAMPS

**OUTLINE MARKER LAMPS**

REAR LAMPS

NUMBER PLATE LAMPS

BEACONS

**ERIOR LAMPS**

LAMPS

NUMBER PLATE HOLDERS

In addition to vehicle lighting of all kinds, cable and plug-in systems round off the wide range of Aspöck products. Always with the highest level of quality, we give our all to fulfil every customer-specific requirement in the best possible way.

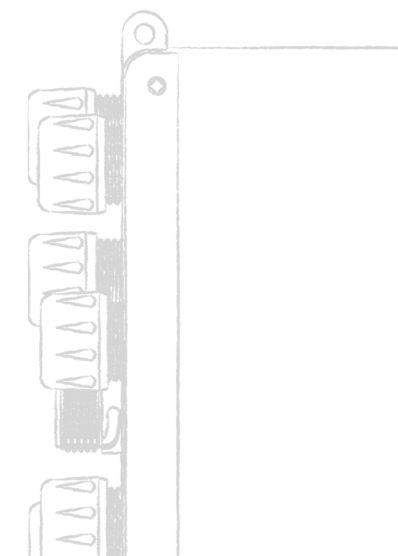
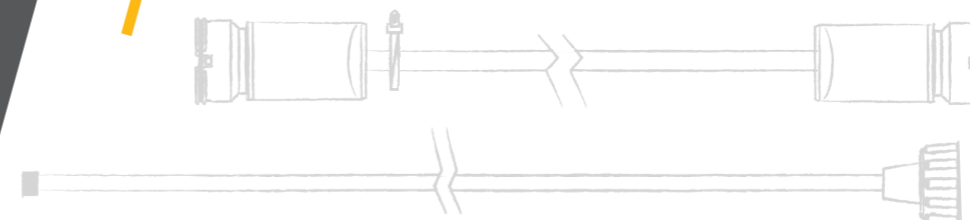
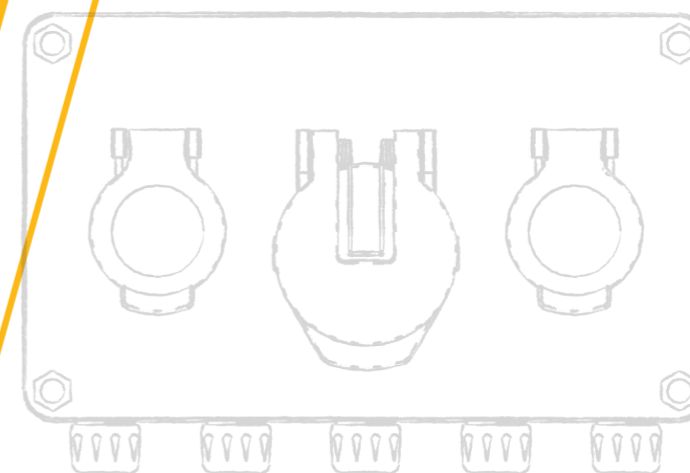

# ASPÖCK WIRING & LIGHT SYSTEMS

## The heart of every vehicle – the wiring.

It provides the connection that makes the lamps shine in the first place.

That is why Aspöck Systems offers a wide range of standard wiring systems for all of the segments that are available to our customers directly from the warehouse, from ADR cables to cables for electronic applications (BUS).

But what would a cable be without a proper connection? There is a wide variety of connector systems available for connecting the cables to various system components. An outstanding example is the ASPÖCK connector system (ASS) developed in-house.

Aspöck is a pioneer, especially in the areas of wiring and junction boxes. We respond to individual customer requests and adapt wiring systems precisely to their requirements with regards to cable length, plug connections, etc.

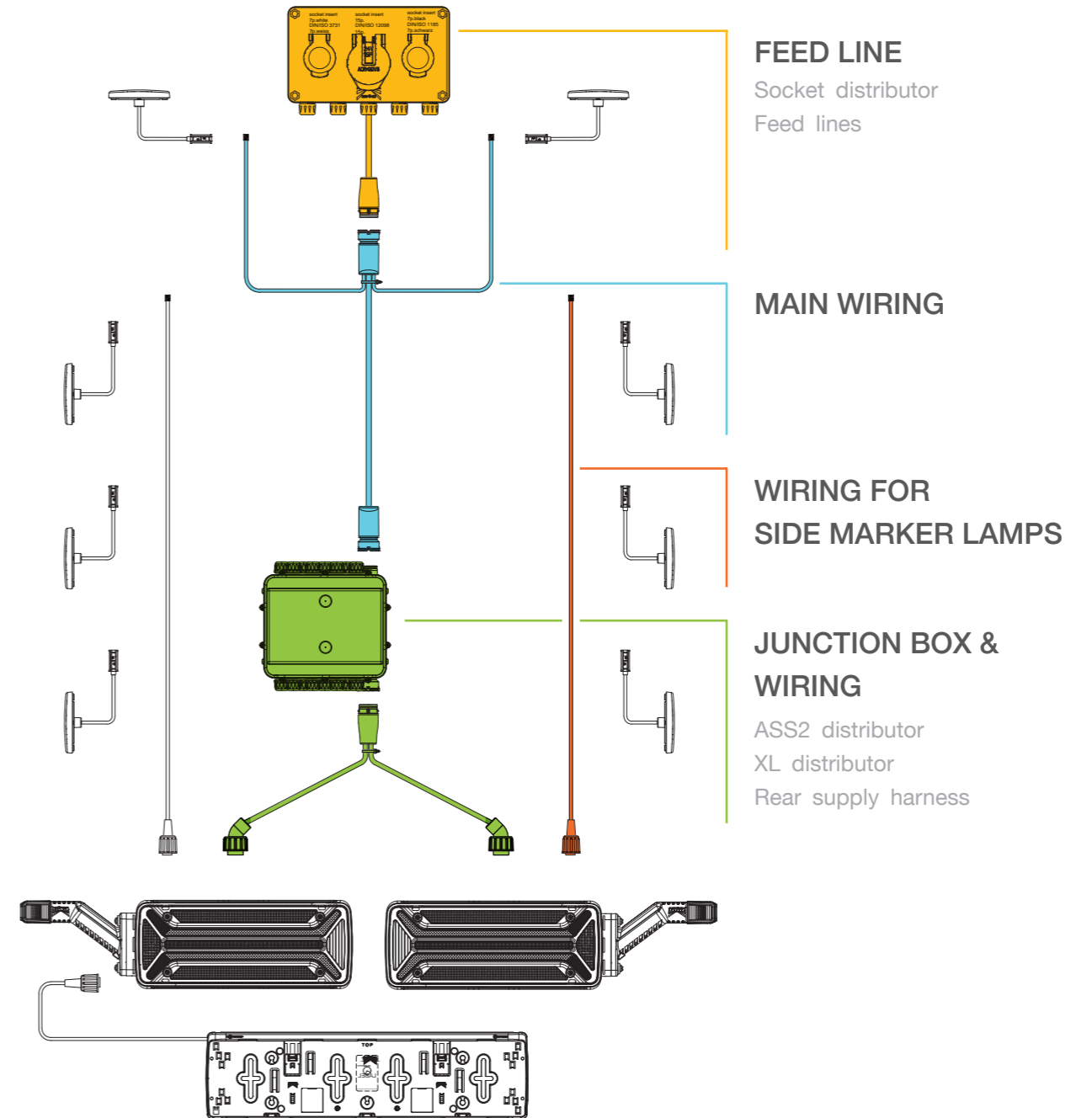

## 3-SOCKET JUNCTION BOX

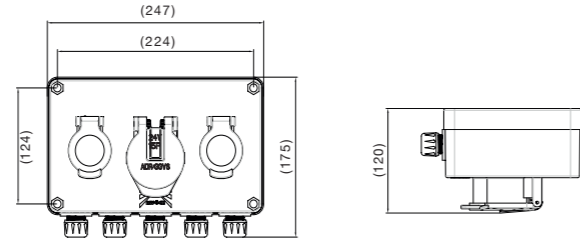

PART NO.	DESCRIPTION	CABLE
76-7037-007	1/- Socket 15-pin ISO 12098 + socket ISO 1185 & 3731 (N+S) ASS3 15-pin female connector	0.60 m
76-7069-007	1/- Socket 15-pin ISO 12098 + socket ISO 1185 & 3731 (N+S) ASS3 15-pin female connector	Direct connection

**This makes the 3-compartment socket distributor permissible for ADR Zone 2:**

To make the socket distributor compatible with ADR travel, you must use the ADR safety caps for the ISO 1185 and ISO 3731 sockets.



PART NO.	DESCRIPTION
15-5280-154	1/- 2-piece safety caps for sockets ISO 1185 and ISO 3731

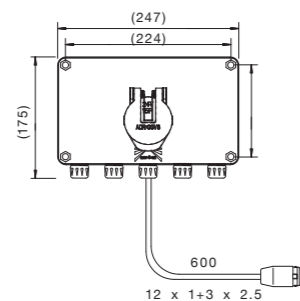

PART NO.	DESCRIPTION	CABLE
76-7072-007	1/- Socket 15-pin ISO 12098 ASS3 15-pin female connector	0.60 m

## FEED LINES

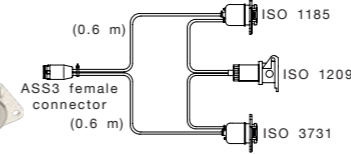

PART NO.	DESCRIPTION	CABLE
58-6647-007	1/- Socket 15-pin ISO 12098 + socket ISO 1185 & 3731 (N+S)	0.60 m

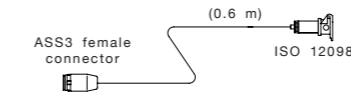

PART NO.	DESCRIPTION	CABLE
53-6768-007	1/- Socket 15-pin ISO 12098	0.60 m

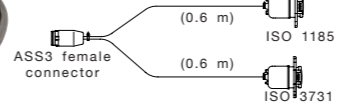

PART NO.	DESCRIPTION	CABLE
58-6649-007	1/- Socket ISO 1185 & 3731 (N+S)	0.60 m

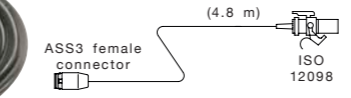

PART NO.	DESCRIPTION	CABLE
53-1667-037	1/- Plug 15-pin ISO 12098	4.80 m

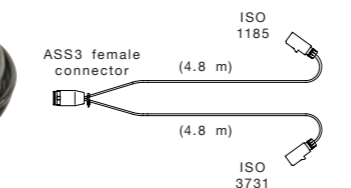

PART NO.	DESCRIPTION	CABLE
58-6024-017	1/- Plug ISO 1185 & 3731 (N+S)	4.80 m

# MAIN CABLES

Main cable with 17-pin ASS3 connection, ADR version

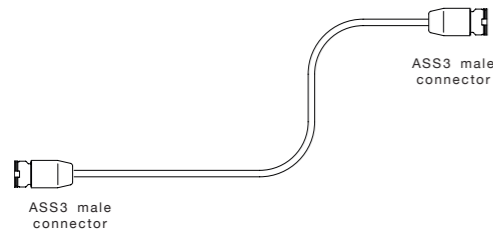

PART NO.	DESCRIPTION	CABLE
65-1003-007	2 x ASS3 15-pin male connector	6 x 1.00 mm <sup>2</sup> + 2 x 2.50 mm 9.00 m
65-1003-017	2 x ASS3 15-pin male connector	6 x 1.00 mm <sup>2</sup> + 2 x 2.50 mm <sup>2</sup> 12.50 m
65-1003-027	2 x ASS3 15-pin male connector	6 x 1.00 mm <sup>2</sup> + 2 x 2.50 mm <sup>2</sup> 15.00 m
65-1005-007	2 x ASS3 15-pin male connector	7 x 1.00 mm <sup>2</sup> + 1 x 1.50 mm <sup>2</sup> + 2 x 2.50 mm <sup>2</sup> 9.00 m
65-1005-017	2 x ASS3 15-pin male connector	7 x 1.00 mm <sup>2</sup> + 1 x 1.50 mm <sup>2</sup> + 2 x 2.50 mm <sup>2</sup> 12.50 m
65-1005-027	2 x ASS3 15-pin male connector	7 x 1.00 mm <sup>2</sup> + 1 x 1.50 mm <sup>2</sup> + 2 x 2.50 mm <sup>2</sup> 15.00 m
65-1007-007	2 x ASS3 15-pin male connector	12 x 1.00 mm <sup>2</sup> + 3 x 2.50 mm <sup>2</sup> 9.00 m
65-1007-017	2 x ASS3 15-pin male connector	12 x 1.00 mm <sup>2</sup> + 3 x 2.50 mm <sup>2</sup> 12.50 m
65-1007-027	2 x ASS3 15-pin male connector	12 x 1.00 mm <sup>2</sup> + 3 x 2.50 mm <sup>2</sup> 15.00 m

# SML WIRING

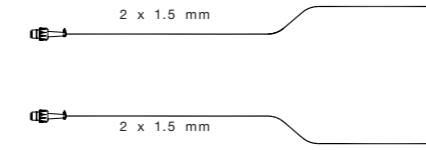

PART NO.	DESCRIPTION	CABLE
68-7503-047	ASS2 2-pin female connector (YL/GN)	P&R flat cable 2 x 1.50 mm <sup>2</sup> (ADR) WH 10.00 m
68-7503-007	ASS2 2-pin female connector (YL/GN)	P&R flat cable 2 x 1.50 mm <sup>2</sup> (ADR) WH 13.00 m
68-7502-367	ASS2 2-pin female connector (YL/GN)	P&R flat cable 2 x 1.50 mm <sup>2</sup> (ADR) YL/GN 13.00 m
68-7503-017	ASS2 2-pin female connector (YL/GN)	P&R flat cable 2 x 1.50 mm <sup>2</sup> (ADR) WH 15.00 m
68-7503-177	ASS2 2-pin female connector (YL/GN)	P&R flat cable 2 x 1.50 mm <sup>2</sup> (ADR) WH 16.00 m
68-7503-027	ASS2 2-pin female connector (YL/GN)	P&R flat cable 2 x 1.50 mm <sup>2</sup> (ADR) WH 17.00 m
68-7502-377	ASS2 2-pin female connector (YL/GN)	P&R flat cable 2 x 1.50 mm <sup>2</sup> (ADR) YL/GN 17.00 m

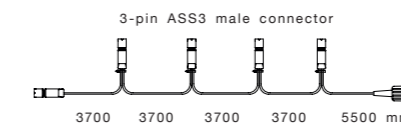

PART NO.	DESCRIPTION	CABLE
87-1284-007	ASS2 2-pin female connector (BL) + 5 x ASS3 2-pin	2 x 1.00 mm <sup>2</sup> (ADR) 1 x 5.50 m + 4 x 3.70 m

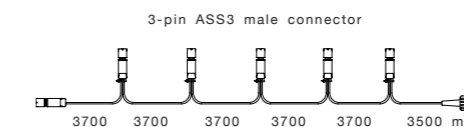

PART NO.	DESCRIPTION	CABLE
87-1285-007	ASS2 2-pin female connector (BL) + 6 x ASS3 2-pin	2 x 1.00 mm <sup>2</sup> (ADR) 1 x 3.50 m + 5 x 3.70 m



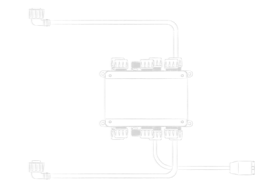

# JUNCTION BOX XL

With improved sealing and an innovative diaphragm ventilation system



ADR Zone 2 IP 56K

## PRODUCT FEATURES

### IMPROVED OVERVIEW

Larger design compared to ASS1

### INNOVATIVE DIAPHRAGM VENTILATION SYSTEM

Prevents negative pressure or overpressure in the junction box

### HIGHER LEAK TIGHTNESS CLASS IP56K

Due to the improved sealing system between cover and housing

### OPTIONAL SPECIAL FUNCTIONS

E.g. relays, SMCG, fuses & diodes, due to integrated relay bases and brackets

### BETTER MAINTENANCE AT CUSTOMER SITE

Option for more organised cable routing

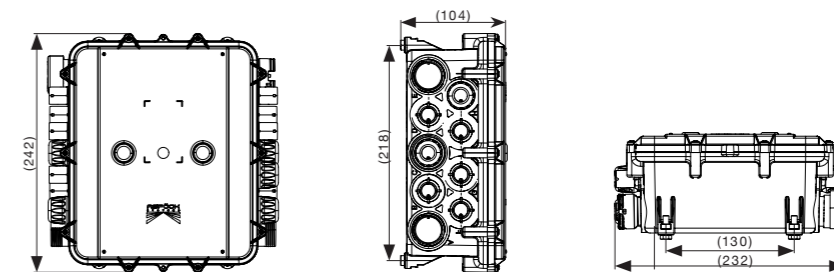

PART NO.		DESCRIPTION
76-5203-007	1/-	Distributor box XL Standard + ASS3

# ASS1 JUNCTION BOX

Safe & simple handling

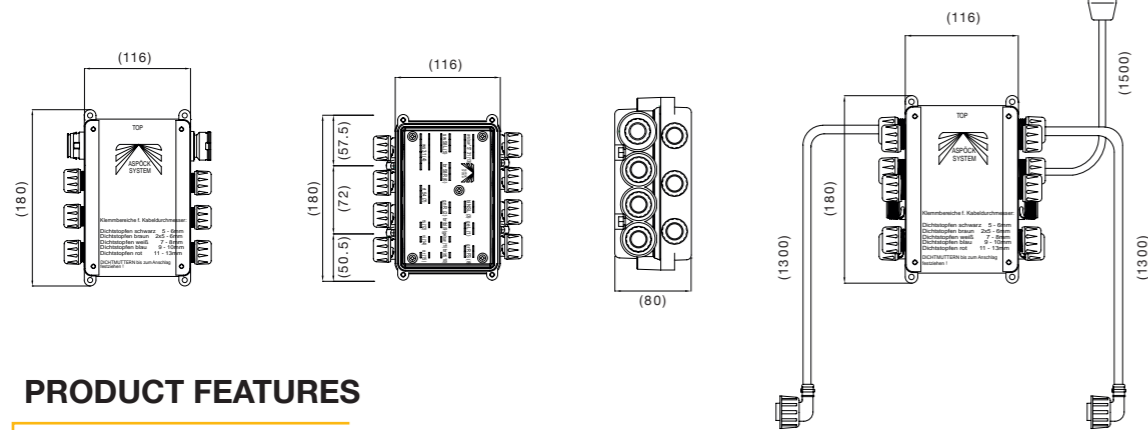

IP 54

## PRODUCT FEATURES

### TIME-SAVING AND LIGHTER INSTALLATION

Pre-wiring possible

### SAFE & SIMPLE HANDLING

No need to open the junction box – IP54 tightness guaranteed

### FUNCTIONS EXPANDABLE

Free inputs on the housing cover serve as reserve inputs

PART NO.	DESCRIPTION	OUTLETS
76-5123-007	Connections: 1 x ASS3 15-pin female connector; 1 x ASS3 15-pin male connector	Not assigned
76-6430-007	Connections: 1 x ASS3 15-pin female connector on 1.50 m 15-pin cable; 2 x ASS2 7-pin female connector (YL/GN) on 1.30 m 7-pin cable	Rear light left + rear light right
76-5123-117	Connections: 1 x ASS3 15-pin female connector	SMCG left & right
76-6430-267	Connections: 1 x ASS3 15-pin female connector on 1.50 m 15-pin cable	SMCG left & right + Rear light left + rear light right

# REAR SUPPLY HARNESS

Connector ASS3 15-pin female connector / 2x ASS2 7-pin female connector

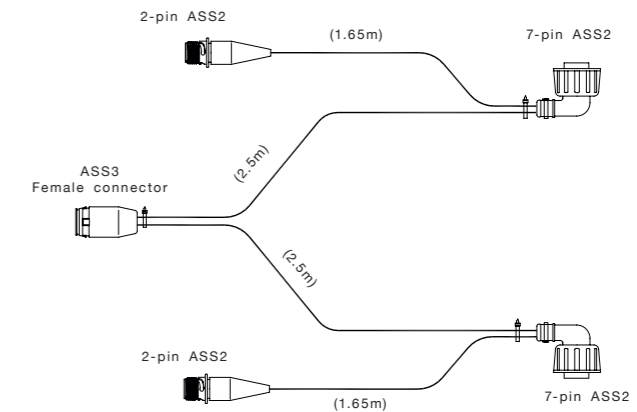

PART NO.	DESCRIPTION	CABLE
68-4800-007	No 2-pin outlet	2 x 2.50 m      2 x 7 x 1 mm <sup>2</sup>
68-4983-007	Outlets: 2 x ASS2 2-pin male connector (YL/GN)	2 x 2.50 m + 2 x 1.70 m      2 x 7 x 1 mm <sup>2</sup> + 2 x 2 x 1.50 mm <sup>2</sup> (P&R)
68-4855-007	Outlets: 1 x P&R flat cable	2 x 3.00 m + 1 x 1.00 m      2 x 7 x 1 mm <sup>2</sup> + 1 x 2 x 1.50 mm <sup>2</sup> (P&R)
68-4888-007	Outlets: 2 x SMCG + ASS2 2-pin male connector (YL/GN)	2 x 2.50 m + 2 x 0.70 m      2 x 7 x 1 mm <sup>2</sup> + 2 x 0.75 mm <sup>2</sup>

# ACCESSORIES

SMCG  
ERD  
REVERSING WARNING DEVICE  
**LCG - LED CONTROL GEAR**  
RDC PREMIUM  
SMARTLINK  
CONTOUR MARKINGS  
EXPANSIONS

NUMBER PLATE LAMPS  
BEACONS  
INTERIOR LAMPS  
**WORK LAMPS**  
NUMBER PLATE HOLDERS  
SIDE MARKER LAMPS  
REVERSING LAMPS  
E LIGHT  
POSITIONS LAMPS  
**OUTLINE MARKER LAMPS**  
REAR LAMPS  
NUMBER PLATE LAMPS  
BEACONS  
**ERIOR LAMPS**  
LAMPS  
NUMBER PLATE HOLDERS

To ensure the greatest possible safety on the roads, your lighting and wiring solutions often need additional accessories.

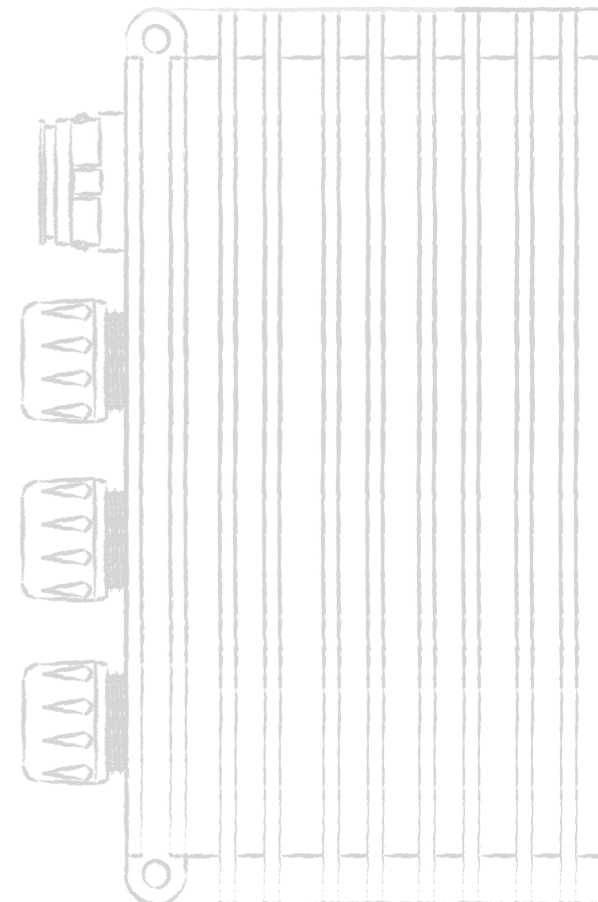

# SMCG - SIDE MARKER CONTROL GEAR

Control for side marker lamps

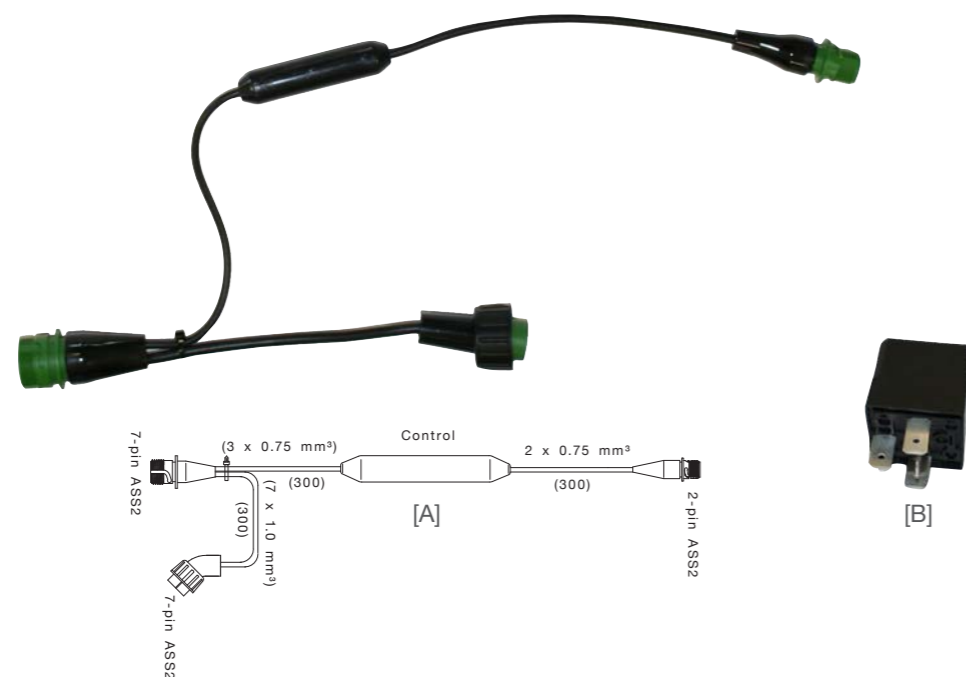

## PRODUCT FEATURES

### SOLUTION FOR REVISED LEGISLATION ECE 48 REV. 6

Side marker lamps must flash along with the indicator

### A LOGICAL APPROACH

Avoids additional fitting of at least three category 5 flashing lights

### UNCOMPLICATED MOUNTING

Simple installation or retrofitting on vehicle

### PROTECTION AGAINST SHORT-CIRCUIT AND OVERTEMPERATURE

Due to integrated electronic circuit

The SMCG – **Side Marker Control Gear** – is the control for the flashing side marker lamp (SML). It was developed as a solution for the revised ECE 48 to Rev. 6 legislation. This regulation states that the side marker lamps on vehicles of class O3 and O4 must flash in coordination with the indicator of the truck. The focus is on significantly increasing safety for all road users when turning (see pictures on the right side).

Aspöck Systems offers individual solutions for the control of the SML that avoid the installation of at least three additional category 5 lamps:

#### Solution 1 – SMCG cable version

This separate wiring with included circuitry provides a cost-effective connection of the rear lamp via the adapter to the side marker lamp.

#### Solution 2 – SMCG relay version

This electronic flasher circuit in a relay [B] is designed for installation in an Aspöck junction box or in an Aspöck rear lamp (Europoint III, Europoint II and Ecopoint II).



Flashing side marker lamps along the truck trailer are a important safety factor for other road users.

PART NO.		DESCRIPTION	VERSION
75-0331-007	1/-	SMCG right + left	[A]
75-0328-007	1/-	SMCG right	[A]
75-0329-007	1/-	SMCG left	[A]
68-4888-007	1/-	Supply harness with SMCG right + left	[A]
76-6430-267	1/-	Rear distributor with SMCG right + left	[A]
12-3970-557	1/-	SMCG relay	[B]

# ERD - ELECTRONIC REVERSING DEVICE

The electronic control for reversing lights

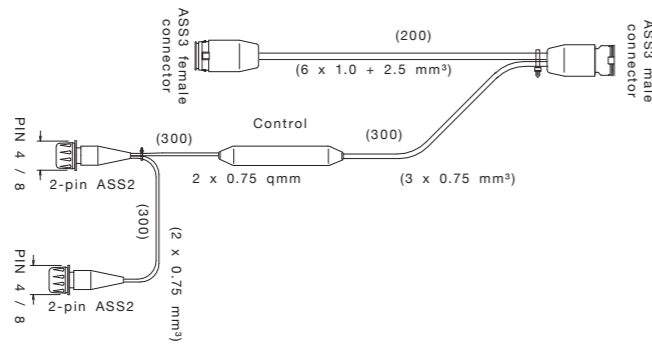

## PRODUCT FEATURES

- FOR ADDITIONAL REVERSE LIGHTS ON VEHICLE**  
Required for additional lamps in line with ECE REG 48
- HIGH LOAD CURRENT**  
Can handle up to max. 8 amps
- UNCOMPLICATED MOUNTING**  
Simple installation or retrofitting on vehicle
- SOLUTION FOR LEGAL PROVISION ECE R48 6.4.7**  
Logical switching of reversing light and rear light

PART NO.	DESCRIPTION
75-0341-007	1/- ERD – reversing light control

# REVERSING ALARMS

Higher safety when reversing

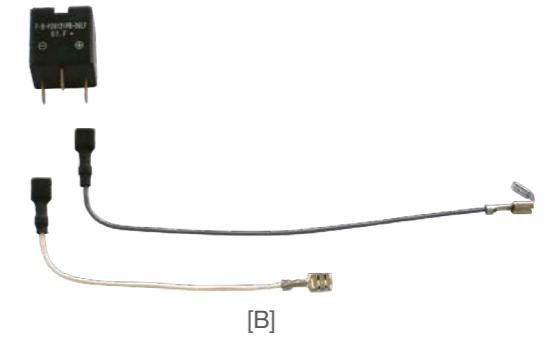
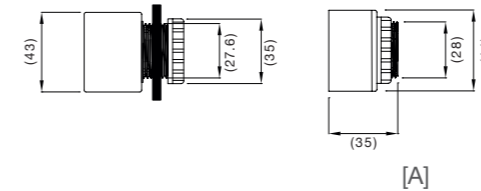

## PRODUCT FEATURES

- PULSATING SIGNAL TONE**  
Sound level 98 dB at 1 m

PART NO.	DESCRIPTION	VERSION
75-0000-007	1.20 m cable and 2-pin ASS1 connector, IP68	[A]
75-0100-007	3.50 m cable open end, IP68	[A]
75-0002-007	1.20 m cable open end, IP54	[A]
12-3922-004	Installation version for Europoint I & Europoint III	[B]
12-3922-014	Installation version for Europoint II	[B]

# LCG - LED CONTROL GEAR

No LED yet? No problem!

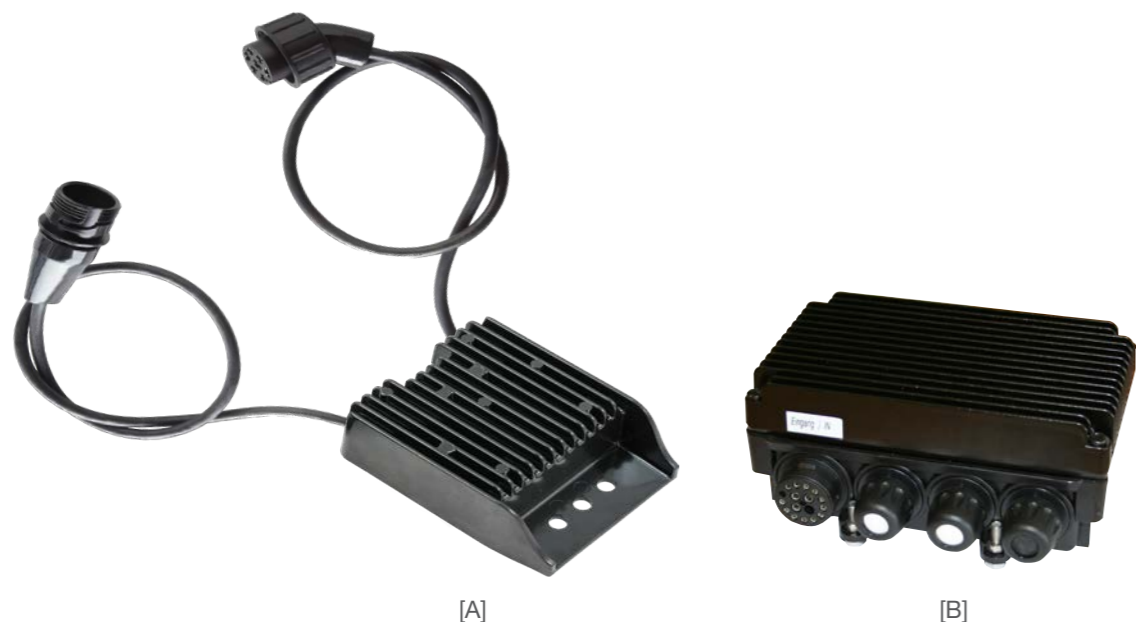

## PRODUCT FEATURES

### LED CONTROL DEVICE

Monitoring of LED direction indicator function

### SOLUTION FOR NON-LED-COMPATIBLE LAMPS

Current matching of LED lamps to those of non-LED-compatible trucks

### UNCOMPLICATED MOUNTING

Quick and simple retrofitting in existing Aspöck light system/rear lamp

With regard to the minimal power consumption of LED lamps compared to incandescent lamps, problems with the light bulb malfunction control can occur during operation of older towing vehicles. The reason for this is that the low power consumption of LED lamps is often interpreted by towing vehicles as a failure of the lighting function.

This **ballast unit (LCG)** adapts the electrical properties of LED lamps to the needs of truck & trailers that are not yet LED-compatible. It also monitors the light function according to legal regulations (current adjustment and failure control as well as overcurrent shutdown).

	LCG 1 - V2	LCG 2	
PART NO.	75-0300-107	75-0310-007	75-0309-007
$V$	24 V	24 V	24 V
TRAILER DETECTION			
LED FAILURE MONITORING			
CURRENT ADJUSTMENT	  	    	   
REQUIRED QUANTITY PER VEHICLE	2	1	1
COMPATIBLE WITH	Aspöck rear lamps without integrated LCG	Aspöck rear lamps without integrated LCG	Aspöck rear lamps with integrated LCG for direction indicator

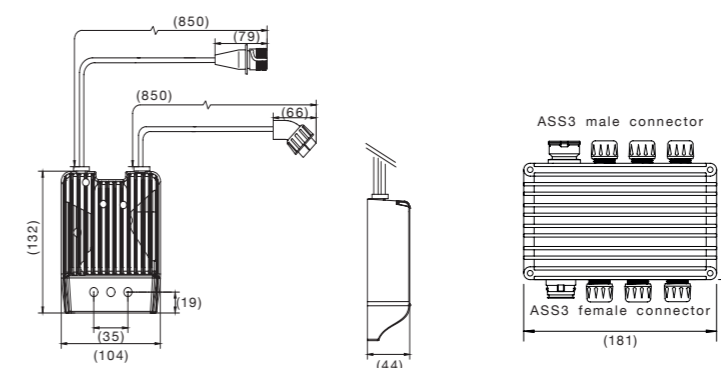

PART NO.		DESCRIPTION	VERSION
75-0300-107	1/-	LCG 1 - V2 with 7-pin ASS2 connection for Aspöck rear lamp	[A]
75-0310-007	1/-	LCG 2 with blinker monitoring + 17-pin ASS3 connection	[B]
75-0309-007	1/-	LCG 2 without blinker monitoring + 17-pin ASS3 connection	[B]

# RDC - RAMP DISTANCE CONTROL PREMIUM

Ramp approach aid using ultrasonic sensors

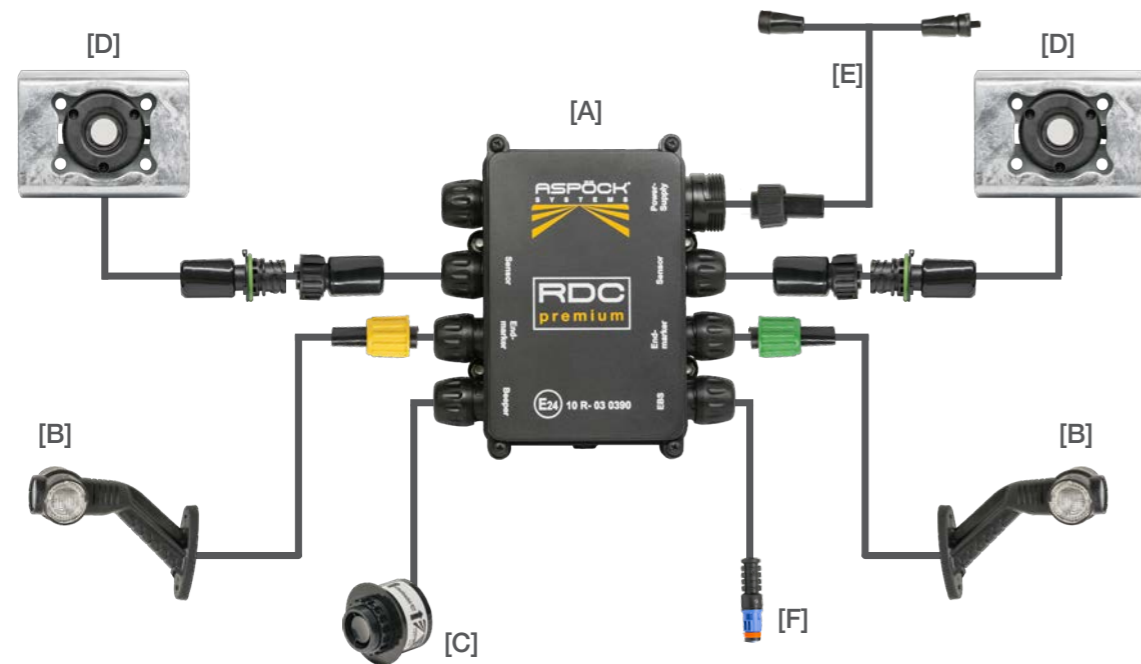

## PRODUCT FEATURES

### RAMP APPROACH AID FOR TRUCK TRAILERS AND SEMI-TRAILERS

Makes approaching ramps easier with acoustic and optical warning signals

### EBS CONNECTION

Optional link to the braking system

### HIGHER SAFETY

For the vehicle and the objects behind the vehicle

### COST SAVINGS

Avoids collisions that could result in damage

### UNCOMPLICATED MOUNTING

Simple installation or retrofitting on vehicles with plug-and-play

Damage, along with enormous repair costs, often occurs when approaching ramps. Thanks to the **Aspöck RDC premium ramp approach aid**, the driver can approach the target in the background with both auditory and visual assistance when reversing.

The system activates automatically at a distance of less than three metres and a speed of less than 10 km/h, and outputs a warning by means of a beeping signal and flashing end-outline marker lamps. Finally, the trailer brakes automatically just before the ramp until it comes to a complete stop.

PART NO.	DESCRIPTION
99-3010-251	RDC Premium Haldex with metal buffer
99-3010-241	RDC Premium Haldex without metal buffer
99-3010-201	RDC Premium Knorr TEBS G2.1 Premium with metal buffer
99-3010-221	RDC Premium Knorr TEBS G2.1 Premium without metal buffer
99-3010-291	RDC Premium Knorr TEBS G2.2 Premium with metal buffer
99-3010-281	RDC Premium Knorr TEBS G2.2 Premium without metal buffer

## RDC – INDIVIDUAL PARTS & ACCESSORIES

PART NO.	DESCRIPTION
76-6425-107	RDC distributor box Haldex [A]
76-6425-207	RDC distributor box Knorr [A]
31-3306-047	URL Superpoint III LED right, with 2.10 m cable [B]
31-3305-047	URL Superpoint III LED left, with 2.10 m cable [B]
75-0001-007	Reversing beeper [C]
75-0201-617	RDC sensor with metal buffer [D]
75-0204-117	RDC sensor without metal buffer
65-6003-017	Connection cable 3.00 m [E]
65-6003-007	Connection cable 8.00 m [E]
68-0049-017	EBS connection cable Haldex 7.00 m [F]
68-0111-007	EBS connection cable Knorr TEBS G2.1 P. 3.00 m [F]
69-0078-017	EBS connection cable Knorr TEBS G2.2 P. 3.00 m [F]

# RADC 1.0 - RADAR DISTANCE CONTROL 1.0

Ramp approach aid using radar technology

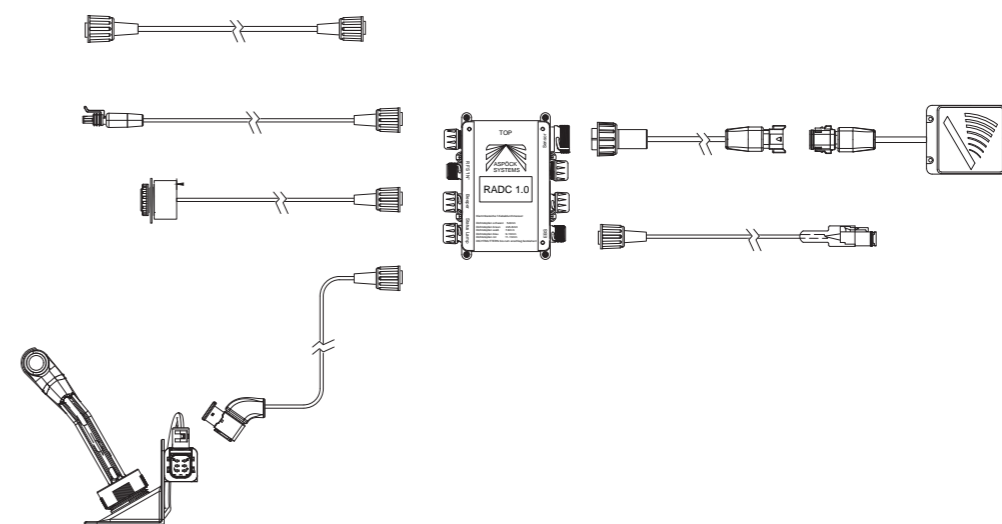
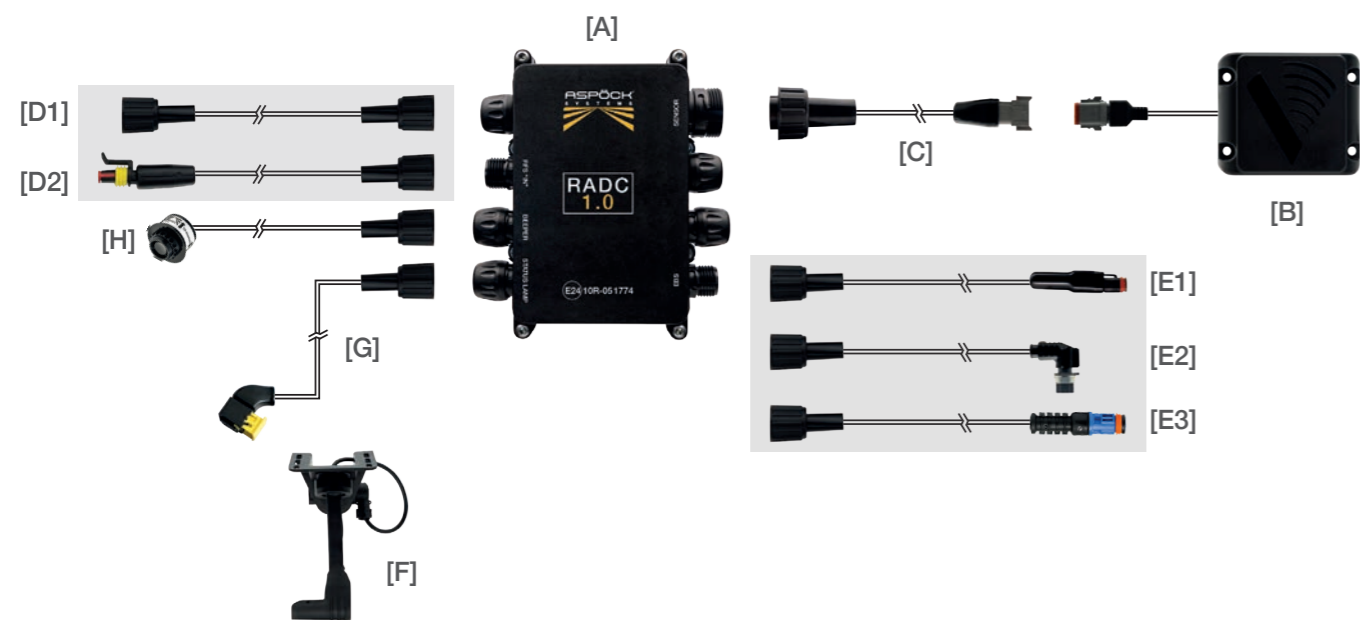

## PRODUCT FEATURES

### RAMP APPROACH AID FOR TRUCK TRAILERS AND SEMI-TRAILERS

Facilitates ramp approach when reversing

### INCREASED SAFETY

Large monitoring area up to 3 x 10 m behind the vehicle

### UNCOMPLICATED MOUNTING

Simple installation or retrofitting on vehicle

### NEW TECHNOLOGY

Only one sensor is required

### CAN BE CONFIGURED

Freely adjustable detection zones

### REGARDLESS OF THE WEATHER

Works despite fog, heavy rain or snowfall

### COST SAVINGS

Thanks to the avoidance of collision damage

PART NO.	DESCRIPTION
76-5158-007	1/- RADC 1.0 distributor box [A]
75-0213-047	1/- RADC sensor W2.4m/L3.0m [B]
65-1512-007	1/- RADC sensor connection cable 3.00 m [C]
68-0076-007	1/- RADC connection cable ASS2 3.00 m [D1]
68-0070-007	1/- RADC Superseal connection cable 6.00 m [D2]
69-0078-027	1/- RADC Knorr EBS Connection 6.00 m DT [E1]
68-0002-337	1/- RADC Knorr EBS Connection 6.00 m DT - 1 pin [E1]
78-7013-007	1/- RADC Wabco/ZF EBS Connection 4.00 m [E2]
68-0049-017	1/- RADC Haldex EBS Connection 7.00 m [E3]
39-9093-007	1/- RADC status light [F]
69-6268-007	1/- RADC status lights connection cable [G]
75-0001-007	1/- Reversing beeper [H]



# SMARTLINK

The easy way to expand multiple functions



## PRODUCT FEATURES

### SIMPLE MOUNTING

By means of mounting holes

### VARIOUS DESIGN OPTIONS

Production of customised variants

### COMPACT DESIGN

Distribution of functions in the smallest possible space

### SIMPLE APPLICATION

"Plug and Play" capable between lamps and rear supply cable

The **Smartlink** is a compact solution for distributing a wide range of functions between the supply line and various consumers, e.g. single- or multi-function lamps. That means it is possible to expand a rear lamp with additional lighting functions in just a few steps.

To do this, simply remove the plug from the rear light and attach the Smart Link adapter with its additional four slots. An additional tail light, stop light, reversing light or flashing light can now be connected and mounted.

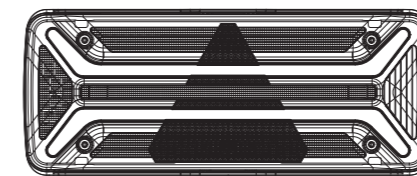
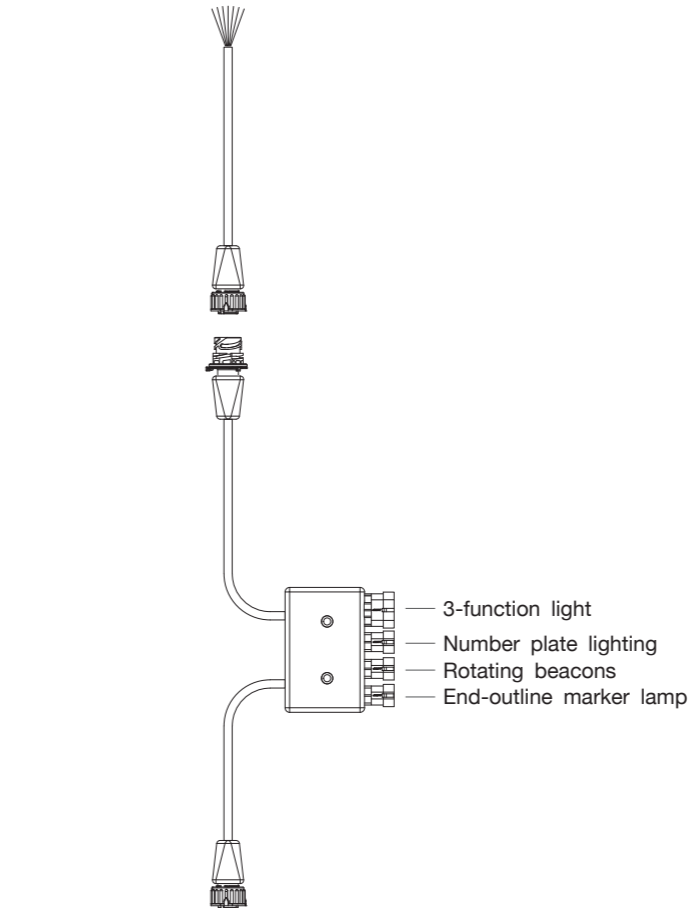
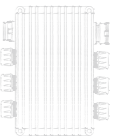

Application example

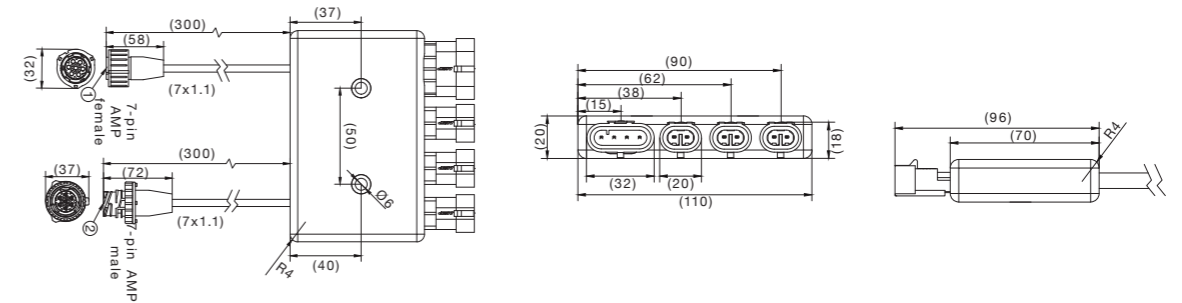

PART NO.	DESCRIPTION	OUTLETS
76-9035-027	1/- Connectors: AMP 7-pin male connector; AMP 7-pin female connector	1 x 3-pin & 3 x 2-pin Superseal
76-9035-037	1/- Connections: 1.50 m 7-pin cable open end; 0.50 m 7-pin cable open end	1 x 3-pin & 3 x 2-pin Superseal
76-9039-007	1/- Connections: ASS2 7-pin male connector; ASS2 7-pin female connector	1 x 3-pin & 3 x 2-pin Superseal
76-9034-007	1/- Connections: 4-pin DT male connector	3 x 2-pin DT male connector

## EXPANSIONS

For extra-wide vehicles

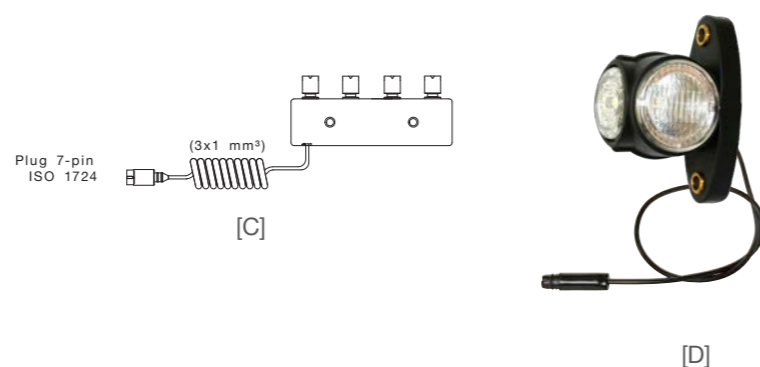
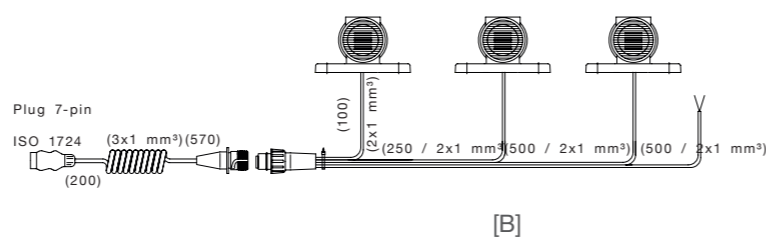
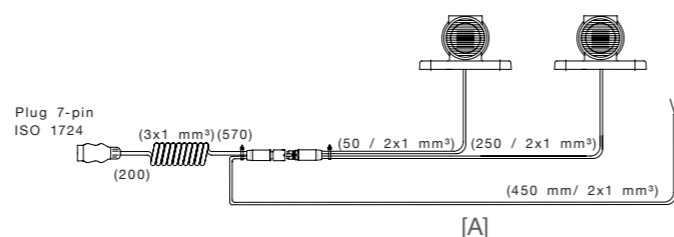

### EXPANSIONS AND ACCESSORIES

PART NO.	DESCRIPTION	
58-1955-007	Expansion with 2 pieces Superpoint III LED, with additional outlet for rotating light	[A]
58-1957-007	Expansion with 3 pieces Superpoint III LED, with additional outlet for rotating light	[B]
76-9023-007	3-pin connector with coiled cable	[C]
31-3307-087	Superpoint III LED 3-pin ASS3 connection suitable for 76-9023-007	[D]



## CONTOUR MARKINGS

The easy way to improve vehicle visibility



### PRODUCT FEATURES

#### SPECIAL ADHESIVE LAYER

Fast and easy to adhere without loss of material

#### REFLECTIVE PROPERTIES

Approved according to EU regulations for reflective materials on trucks and trailers

#### SPECIAL MATERIAL COMPOSITION

This makes the product thin, flexible and very tear-resistant

#### ACRYLIC STRUCTURE

The acrylic top layer provides excellent stability

PART NO.	DESCRIPTION
15-5990-007	50.80 mm x 50 m white
15-5990-107	50.80 mm x 50 m yellow
15-5990-207	50.80 mm x 50 m red
15-5990-407	For curtain sider 50.80 mm x 50 m white
15-5990-507	For curtain sider 50.80 mm x 50 m yellow
15-5990-607	For curtain sider 50.80 mm x 50 m red

# UNDERRUN PROTECTION

Underrun protection according to UNECE regulation no. 58 Rev. 03

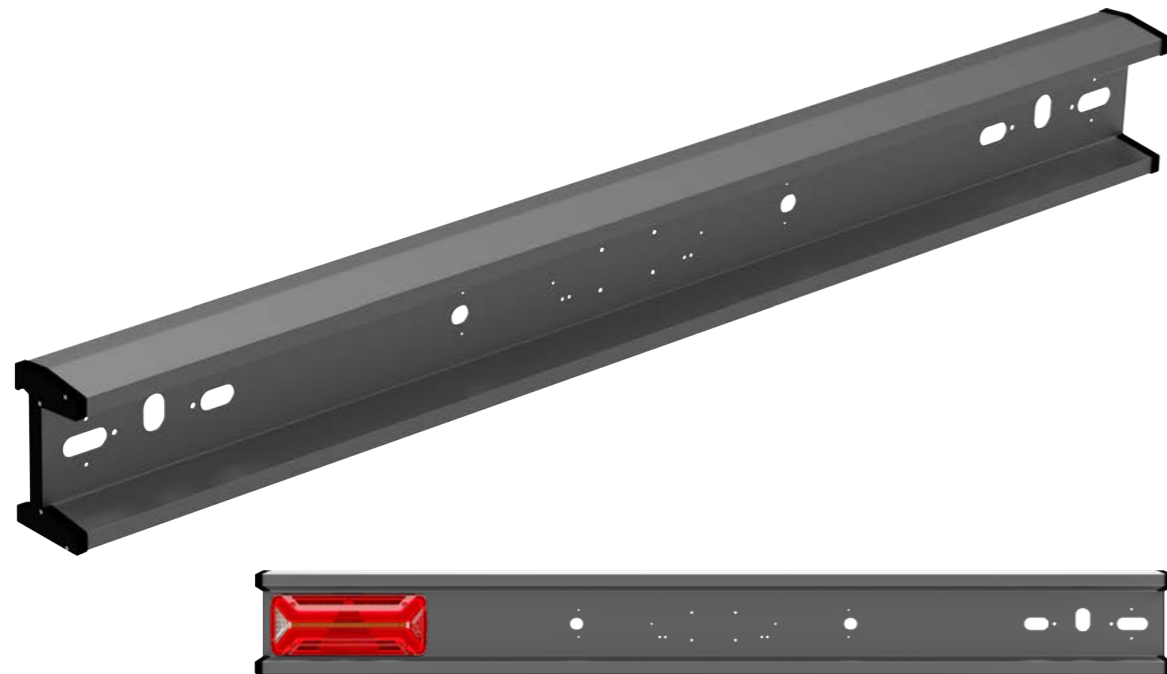

## PRODUCT FEATURES

### INCREASED SAFETY

Protects smaller vehicles from driving under in the event of collisions

### IMPROVED GEOMETRY

Can handle up to 180 kN

### OPTIONAL NEW HOLE PATTERN VERSIONS

For combination rear lamps with distribution function

### LOWER COSTS

Due to pre-mounted wiring

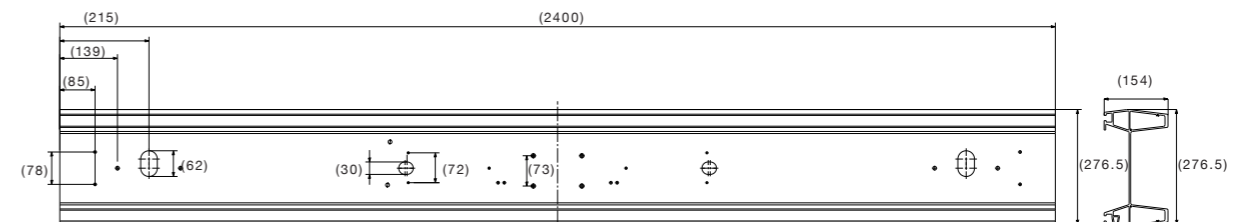

## UNDERRUN PROTECTION

PART NO.		DESCRIPTION
97-1103-011	25	Underrun protection according to ECE58 R03, anodised aluminium, for 3-chamber lamp, 2,400 mm
97-1104-011	25	Underrun protection according to ECE58 R03, anodised aluminium, for 5-chamber lamp, 2,400 mm
97-1105-011	25	Underrun protection according to ECE58 R03, anodised aluminium, undrilled, 2,400 mm
97-1106-011	25	Underrun protection according to ECE58 R03, anodised aluminium, standard, 2,400 mm
97-1107-011	25	Underrun protection according to ECE58 R03, aluminium white, undrilled, 2,400 mm

# WIRING SOLUTIONS

The right wiring is the be-all and end-all for a fully functional vehicle. Aspöck Systems offers market-driven solutions that can be individually adapted to the customer's requirements.

NUMBER PLATE LAMPS  
BEACONS  
INTERIOR LAMPS  
**WORK LAMPS**  
NUMBER PLATE HOLDERS  
SIDE MARKER LAMPS  
REVERSING LAMPS  
E LIGHT  
POSITIONS LAMPS  
**OUTLINE MARKER LAMPS**  
REAR LAMPS  
NUMBER PLATE LAMPS  
BEACONS  
**ERIOR LAMPS**  
LAMPS  
NUMBER PLATE HOLDERS

## STANDARD WIRING WITH SMCG

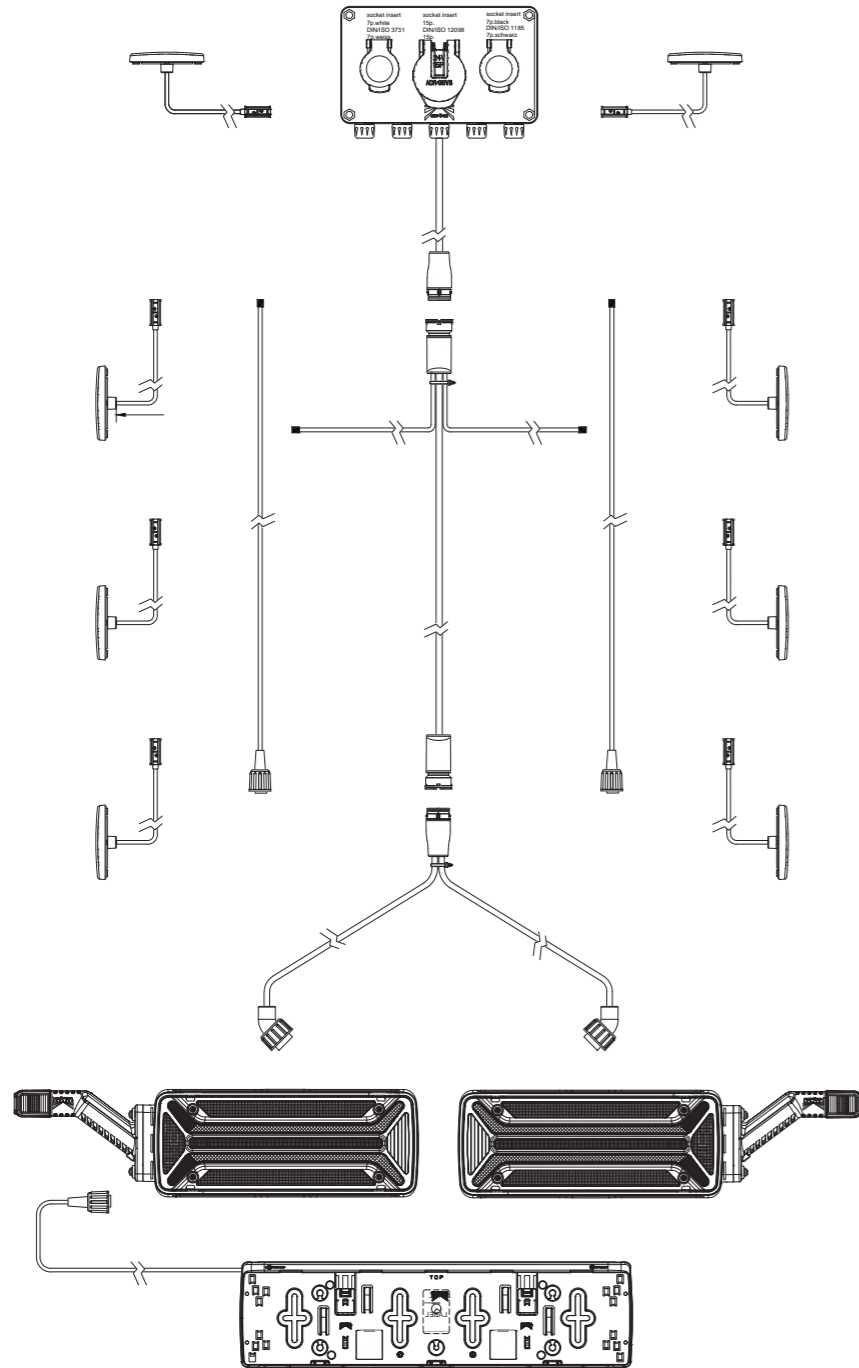

### NOTES

---



---



---

## STANDARD WIRING WITH FLASHING SIDE MARKER LAMPS

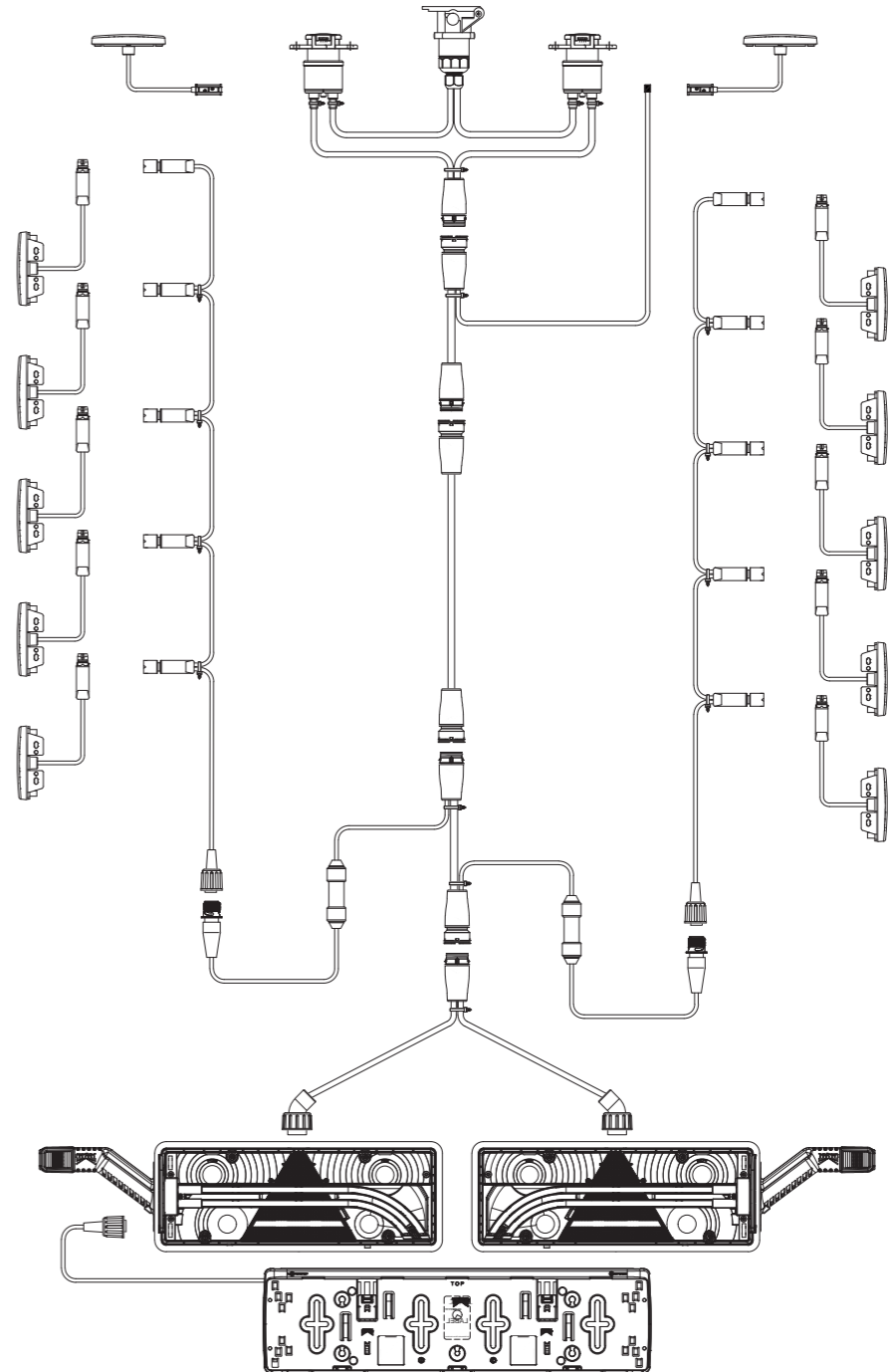

### NOTES

---



---



---

# MOUNTING REGULATIONS

REAR LIGHTING  
**SIDE LIGHTING**  
FRONT LIGHTING

NUMBER PLATE LIGHTS  
ROTATING BEACONS  
PLUG-IN DIAGRAM

**WORK LAMPS**

NUMBER PLATE HOLDERS  
SIDE MARKER LAMPS  
REVERSING LIGHTS

E LIGHT

NAVIGATION LIGHTS

**OUTLINE MARKER LAMPS**

REAR LAMPS

NUMBER PLATE LIGHTS

ROTATING BEACONS

**FRONT LIGHTS**

LAMPS

NUMBER PLATE HOLDERS

Based on the adopted regulations, the law requires compliance with different provisions for the installation of vehicle lights. These and other regulations concerning vehicles can be found in the ECE regulations.



# MOUNTING REQUIREMENTS

## For trailers according to ECE regulation R48

Aspöck Systems has summarised and presented the most important legal mounting regulations for the optimum fitting or retrofitting of a trailer with rear, front and side lighting. Due to the changing legal regulations at irregular intervals, Aspöck does not assume any warranty for possible deviations.

### Vehicle classes:

O1 trailer up to 0.75 t | O2 trailer over 0.75 t up to 3.5 t | O3 trailer over 3.5 t up to 10 t | O4 trailer over 10 t

## REAR LIGHTING - TRAILER

REAR POSITION LAMP ECE-R48 § 6.10 AND ECE-R7	
<b>Attachment</b> ECE-R48 § 6.10.1	Mandatory for all trailers. Category R, R1 or R2.
<b>Quantity</b> ECE-R48 § 6.13.2	2 pieces, 2 additional possible on O2, O3 and O4 vehicles if no end-outline marker lamps are mounted.
<b>Colour</b> ECE-R48 § 5.15	Red
<b>Mounting width</b> ECE-R48 § 6.10.4.1	Max. 400 mm from the outermost point of the vehicle width. This does not apply to the additional vehicle position lamps. Min. 600 mm between both tail lights, but min. 400 mm for vehicle widths < 1,300 mm.
<b>Mounting height</b> ECE-R48 § 6.10.4.2	Min. 350 mm, max. 1,500 mm (exception: 2,100 mm only if the vehicle geometry does not allow mounting below 1,500 mm and if no 2 additional vehicle position lamps are fitted). Mounting height of the additional vehicle position lamps: Min. 600 mm above the mandatory vehicle position lamps.
<b>Geom. viewing angle</b> ECE-R48 § 6.10.5	Horizontal 45° inside to 80° outside. Vertical ±15°, but with mounting height < 750 mm also 5° downwards. Optionally with an attachment height of 2,100 m also 5° upwards
<b>Electrical circuit</b> ECE-R48 § 6.10.7	Must be designed so that the front position, tail, side marker lamps and number plate lights can only be switched on and off simultaneously.
<b>Switch-on control</b> ECE-R48 § 6.10.8	Mandatory. It must be combined with the control device for the front position lamps.
<b>Other regulations</b> ECE-R48 § 6.10.9	Unless end-outline marker lamps are fitted, 2 additional front position and vehicle position lamp may be fitted to all trailers of categories O2, O3, O4.
<b>ECE-R7 § 6.1</b> Category R, R1 (constant) = light intensity min. 4 cd, single lamp max. 17 cd, type "D" lamp max. 8.5 cd Category R2 (variable) = light intensity min. 4 cd, single lamp max. 42 cd, type "D" lamp max. 21 cd	

### STOP LAMP ECE-R48 § 6.7 AND ECE-R7

<b>Attachment</b> ECE-R48 § 6.7.1	Mandatory for all trailers. Category S1 or S2.
<b>Quantity</b> ECE-R48 § 6.7.2	2 pieces. Except if stop lamps in category S3 or S4 are installed, two additional stop lamps in category S1 or S2 can be installed to vehicle classes O2, O3 and O4.
<b>Colour</b> ECE-R48 § 5.15	Red
<b>Mounting width</b> ECE-R48 § 6.7.4.1	For all trailers min. 600 mm between both stop lamps, but min. 400 mm for vehicle widths < 1,300 mm.
<b>Mounting height</b> ECE-R48 § 6.7.4.2	Min. 350 mm, max. 1,500 mm (exception: 2,100 mm, only if the vehicle geometry does not allow for an installation of less than 1,500 mm and 2 additional stop lamps are not installed). Position in height of the additional stop lamps: min. 600 mm above the mandatory stop lamps.
<b>Geom. viewing angle</b> ECE-R48 § 6.7.5	Horizontal ± 45°. Vertical ± 15°, but for a position in height of < 750 mm also 5° downwards. Optionally with a position in height of 2,100 mm also 5° upwards.
<b>Electrical circuit</b> ECE-R48 § 6.7.7	Must shine when the brake is pressed.
<b>Switch-on control</b> ECE-R48 § 6.7.8	Optional, however, a tell-tale indicating failure is mandatory if required by the component regulation. If there is one, only as an operating tell-tale in the shape of a non-flashing warning lamp that lights up in the event of a fault.
<b>Other regulations</b> ECE-R48 § 6.7.9	The distance between the stop lamp and each rear fog lamp must be ≥ 100 mm.
<b>ECE-R7 § 6.1</b> Category S1 (constant) = light intensity min. 60 cd, single lamp max. 260 cd, type "D" lamp max. 130 cd Category S2 (variable) = light intensity min. 60 cd, single lamp max. 730 cd, type "D" lamp max. 365 cd	

REAR DIRECTIONAL INDICATOR ECE-R48 § 6.5 AND ECE-R6	
<b>Attachment</b> ECE-R48 § 6.5.1	Mandatory for all trailers. Category 2a or 2b.
<b>Quantity</b> ECE-R48 § 6.5.2	2 pieces, additionally 2 optional ones at O2-, O3- and O4 vehicles
<b>Colour</b> ECE-R48 § 5.15	Yellow
<b>Mounting width</b> ECE-R48 § 6.5.4.1	Max. 400 mm from the outermost point of the vehicle width. This does not apply to the additional blinkers. Min. 600 mm between both blinkers, but min. 400 mm for vehicle widths < 1,300 mm.
<b>Mounting height</b> ECE-R48 § 6.5.4.2	Min. 350 mm, max. 1,500 mm (exception: 2,100 mm only if the vehicle geometry does not allow mounting below 1,500 mm and if no 2 additional vehicle position lamps are fitted). Mounting height of the additional blinkers: Min. 600 mm above the mandatory blinkers.
<b>Geom. viewing angle</b> ECE-R48 § 6.5.5	Horizontal 45° inside to 80° outside. Vertical ±15°, but with mounting height < 750 mm also 5° downwards. Optionally with an attachment height of 2,100 m also 5° upwards.
<b>Electrical circuit</b> ECE-R48 § 6.5.7	The illumination must be independent of other lamps. They must be illuminated and extinguished on the same side of the vehicle by the same controls. They must flash synchronously.
<b>Switch-on control</b> ECE-R48 § 6.13.8	Mandatory. The function control is mandatory for the front and rear directional indicators. Vehicles equipped to tow a trailer must be equipped with a special function control for the directional indicators of the trailer, unless any malfunction of one of the directional indicators of the vehicle chain can be read off the control device of the towing vehicle. A functional check is not required for the two additional directional indicators on trailers.
<b>ECE-R6 (6.1)</b> Category 2a (constant) = light intensity min. 50 cd, single lamp max. 500 cd, type "D" lamp max. 250 cd Category 2b (variable) = light intensity min. 50 cd, single lamp max. 1,000 cd, type "D" lamp max. 500 cd	

# REAR LIGHTING - TRAILER

REVERSING LIGHT ECE-R48 § 6.4 AND ECE-R23	
<b>Attachment</b> ECE-R48 § 6.4.1	Mandatory for all trailers of vehicle classes O2, O3 and O4. Permitted for trailers of vehicle category O1.
<b>Quantity</b> ECE-R48 § 6.4.2	1 piece mandatory, a 2nd piece permissible for trailers < 6 m. 2 pieces prescribed for trailers > 6 m and 2 additional permissible*
<b>Colour</b> ECE-R48 § 5.15	White
<b>Mounting width</b> ECE-R48 § 6.4.4.1	No regulation
<b>Mounting height</b> ECE-R48 § 6.4.5	Min. 250 mm, max. 1,200 mm.
<b>Geom. viewing angle</b> ECE-R48 § 6.4.5	1 lamp: Horizontal ± 45°. 2 lamps: Horizontal 30° inwards to 45° outwards. Vertical 15° upwards, to 5° downwards.
<b>Electrical circuit</b> ECE-R48 § 6.4.7	Only switched on when reverse gear is engaged and the vehicle is ready to drive. For the optional reversing lights, special conditions apply in § 6.4.7.2.
<b>Switch-on control</b> ECE-R48 § 6.4.8	Permissible

\* Mounting of the two optional reversing lights also permitted on the side of the vehicle.

REAR FOG LAMP ECE-R48 § 6.11 AND ECE-R38	
<b>Attachment</b> ECE-R48 § 6.11.1	Mandatory for all trailers. Category F, F1 or F2.
<b>Quantity</b> ECE-R48 § 6.13.2	1 or 2 pieces
<b>Colour</b> ECE-R48 § 5.15	Red
<b>Mounting width</b> ECE-R48 § 6.11.4.1	No regulation
<b>Mounting height</b> ECE-R48 § 6.11.4.2	Min. 250 mm, max. 1,000 mm or if built together with other function max. 1,200 mm.
<b>General mounting information</b> ECE-R48 § 6.11.4.1	With 1 rear fog lamp: Left of centre = right-hand traffic, right of centre = left-hand traffic. Mounting in the centre is permissible.
<b>Geom. viewing angle</b> ECE-R48 § 6.11.5	Horizontal ± 25°. Vertical ± 5°.
<b>Electrical circuit</b> ECE-R48 § 6.11.7	Switch-on only when low beam, high beam or fog lights are switched on.
<b>Switch-on control</b> ECE-R48 § 6.11.8	Mandatory. An independent, non-flashing indicator light.
<b>Other regulations</b> ECE-R48 § 6.11.9	The distance to the stop light must be > 100 mm. The rear fog lamp of the towing vehicle can switch off automatically if a trailer is coupled and its rear fog lamp is switched on as a result.

**ECE-R38 § 6.1**  
Category F, F1 (constant) = light intensity min. 150 cd, max. 300 cd Category F2 (variable) = light intensity min. 150 cd, max. 840 cd

NUMBER PLATE LIGHT ECE-R48 § 6.8 AND ECE-R4	
<b>Attachment</b> ECE-R48 § 6.15.1	Mandatory for all trailers.
<b>Quantity</b> ECE-R48 § 6.8.2	1 or more
<b>Colour</b> ECE-R48 § 5.15	White
<b>Mount of the number plate</b> ECE-R48 § 6.8.3	so that the numbers are illuminated.
<b>Electrical circuit</b> ECE-R48 § 6.8.7	Must be designed so that the front position, number plate, tail and side marker lamps can only be switched on and off simultaneously.
<b>Switch-on control</b> ECE-R48 § 6.8.8	Permitted. If a control device is used, its function must be fulfilled by the control device prescribed for the front position and vehicle position lamps.

REAR RETRO-REFLECTOR ECE-R48 § 6.15 AND ECE-R3	
<b>Attachment</b> ECE-R48 § 6.15.1	Mandatory for all trailers.
<b>Quantity</b> ECE-R48 § 6.15.2	Min. 2 pieces
<b>Colour</b> ECE-R48 § 5.15	Red
<b>Shape</b> ECE-R48 § 6.15	Triangle
<b>Mounting scheme</b> ECE-R48 § 6.15.3	The tip of the triangle must point upwards.
<b>Mounting width</b> ECE-R48 § 6.15.4.1	Max. 400 mm from the outermost point of the vehicle width. Min. 600 mm between both retro-reflectors, but min. 400 mm for vehicle widths < 1,300 mm.
<b>Mounting height</b> ECE-R48 § 6.15.4.2	Min. 250 mm, max. 900 mm, max. 1,200 mm if integrated in other lamps (exception: 1,500 mm)*.
<b>Geom. viewing angle</b> ECE-R48 § 6.15.5	Horizontal ± 30°. Vertical ±15°, but with mounting height < 750 mm 5° downwards.
<b>Other regulations</b> ECE-R48 § 6.15.9	The illuminating surface of the retro-reflector may be integrated in any other rear light.

\* An exception is only possible if the vehicle geometry does not allow for normal mounting.

REAR END-OUTLINE MARKER LAMP ECE-R48 § 6.13 AND ECE-R7	
<b>Attachment</b> ECE-R48 § 6.13.1	Mandatory for trailers > 2.1 m wide. Permitted for trailers > 1.8 m to ≤ 2.1 m wide. Category R, R1, R2, RM1 or RM2.
<b>Quantity</b> ECE-R48 § 6.13.2	2 pieces, optionally 2 additional end-outline marker lamp possible
<b>Colour</b> ECE-R48 § 5.15	Red
<b>Mounting width</b> ECE-R48 § 6.13.4.1	As far out as possible, max. 400 mm from the outermost point of the vehicle width.
<b>Mounting height</b> ECE-R48 § 6.13.4.2	As high as possible. Optional and prescribed with the greatest possible distance.
<b>Geom. viewing angle</b> ECE-R48 § 6.13.5	Horizontal 80° outwards. Vertical 5° above and 20° below the horizontal.
<b>Electrical circuit</b> ECE-R48 § 6.13.7	Must be designed so that the front position, tail, side marker lamps and number plate lights can only be switched on and off simultaneously.
<b>Switch-on control</b> ECE-R48 § 6.13.8	Permitted. If a control device is used, its function must be fulfilled by the control device prescribed for the front position and vehicle position lamps.
<b>Other regulations</b> ECE-R48 § 6.13.9	The rear red and the front white end-outline marker lights may be combined in one lamp, provided that the installation regulations and viewing angle ranges are complied with. Distance between end-outline marker lamp and vehicle position lamp min. 200 mm.

**ECE-R7 § 6.1**  
Category R, R1, RM1 (constant) = light intensity min. 4 cd, single lamp max. 17 cd, type "D" lamp max. 8.5 cd  
Category R2, RM2 (variable) = light intensity min. 4 cd, single lamp max. 42 cd, type "D" lamp max. 21 cd



## SIDE LIGHTING - TRAILER

SIDE RETRO-REFLECTOR ECE-R48 § 6.17 AND ECE-R3	
<b>Attachment</b> ECE-R48 § 6.17.1	Mandatory for all trailers.
<b>Quantity</b> ECE-R48 § 6.17.2	See length attachment
<b>Colour</b> ECE-R48 § 5.15	Yellow
<b>Shape</b> ECE-R48 § 6.17	Not triangular
<b>Mounting height</b> ECE-R48 § 6.17.4.2	Min. 250 mm, max. 900 mm, max. 1,200 mm if integrated in other lamps (exception: 1,500 mm).
<b>Length attachment</b> ECE-R48 § 6.17.4.3	The reflector furthest forward must not be more than 3 m from the foremost point of the vehicle. Max. 3 m between the individual retro-reflectors (exception: 4 m). Max. distance from rear 1 m. Min. 1 retro-reflectors in the middle third.
<b>Geom. viewing angle</b> ECE-R48 § 6.17.5	Horizontal ± 45°. Vertical ±10°, but with mounting height < 750 mm 5° downwards.
<b>Other regulations</b> ECE-R48 § 6.17.9	The illuminating surface of the retro-reflector may be integrated in any other side lamp.

SIDE MARKER LAMP (SM1) ECE-R48 § 6.18 AND ECE-R91	
<b>Attachment</b> ECE-R48 § 6.18.1	Mandatory for trailers > 6 m length. Permitted for trailers < 6 m length.
<b>Quantity</b> ECE-R48 § 6.18.2	See length attachment
<b>Colour</b> ECE-R48 § 5.15	Front yellow, rear yellow (in combination with the rear lamp red also possible).
<b>Mounting height</b> ECE-R48 § 6.18.4.2	No regulation
<b>Mounting height</b> ECE-R48 § 6.11.4.2	Min. 250 mm, max. 1,500 mm (exception: 2,100 mm)*.
<b>Length attachment</b> ECE-R48 § 6.18.4.3	Front side marker lamp max. 3 m from the front, rearmost side marker lamp max. 1 m from the rear, max. 3 m between the individual side marker lights (exception: 4 m). Min. 1 in the front and / or rear third. For vehicle lengths ≤ 6 m, alternatively min. 1 in the middle third.
<b>Geom. viewing angle</b> ECE-R48 § 6.18.5	Horizontal ± 45°, ± 30° for optional side marker lamps. Vertical ±10°, but with mounting height < 750 mm 5° downwards.
<b>Electrical circuit</b> ECE-R48 § 6.18.8	No regulation
<b>Switch-on control</b> ECE-R48 § 6.18.8	Mandatory. If used, its function must be fulfilled by the control device prescribed for the front position and vehicle position lamps.
<b>Other regulations</b> ECE-R48 § 6.18.9	The illuminating surface of the retro-reflector may be integrated in the side marker lamp. The maximum mounting height of the retro-reflector must be observed. The rear side marker lamp must be yellow if it flashes together with the rear directional indicator.

\* An exception is only possible if the vehicle geometry does not allow for normal mounting.

**ECE-R91 (7.1)**  
Category SM1 (use on all vehicle classes) = light intensity min. 4 cd, max. 25 cd

## FRONT LIGHTING - TRAILER

FRONT POSITION LAMP ECE-R48 § 6.9 AND ECE-R7	
<b>Attachment</b> ECE-R48 § 6.9.1	Mandatory for trailers > 1.6 m wide. Permitted for trailers ≤ 1.6 m wide.
<b>Quantity</b> ECE-R48 § 6.9.2	2 pieces
<b>Colour</b> ECE-R48 § 5.15	White
<b>Shape</b> ECE-R48 § 6.16	Not triangular
<b>Mounting width</b> ECE-R48 § 6.9.4.1	Max. 150 mm from the outermost point of the vehicle width. Min. 600 mm between both front position lamps, but min. 400 mm for vehicle widths < 1,300 mm.
<b>Mounting height</b> ECE-R48 § 6.9.4.2	Min. 250 mm, max. 1,500 mm (exception: 2,100 mm only for trailers from categories O1 and O2 or if max. 1,500 mm is not possible for other trailers).
<b>Geom. viewing angle</b> ECE-R48 § 6.9.5	Horizontal 5° inwards and 80° outwards. Vertical ±15°, but with mounting height < 750 mm also 5° downwards.
<b>Other regulations</b> ECE-R48 § 6.16.9	The illuminating surface of the retro-reflector may be integrated in any other front light.
<b>Electrical circuit</b> ECE-R48 § 6.9.7	Must be designed so that the front position, tail, side marker lamps and number plate lights can only be switched on and off simultaneously. May be switched off during flashing.
<b>Switch-on control</b> ECE-R48 § 6.9.8	Mandatory. The indicator light must not flash. Not required if the instrument panel lighting system can only be switched on simultaneously with the front position lamps.

FRONT END-OUTLINE MARKER LAMP ECE-R48 § 6.13 AND ECE-R7	
<b>Attachment</b> ECE-R48 § 6.13.1	Mandatory for trailers > 2.1 m wide. Permitted for trailers > 1.8 m wide to ≤ 2.1 m wide. Category A or AM
<b>Quantity</b> ECE-R48 § 6.13.2	2 pieces, optionally 2 additional permitted
<b>Colour</b> ECE-R48 § 5.15	White
<b>Mounting width</b> ECE-R48 § 6.13.4.1	Max. 400 mm from the outermost point of the vehicle width.
<b>Mounting height</b> ECE-R48 § 6.13.4.2	As high as possible.
<b>Geom. viewing angle</b> ECE-R48 § 6.13.5	Horizontal 80° outwards, vertical 5° above and 20° below the horizontal.
<b>Electrical circuit</b> ECE-R48 § 6.13.7	Must be designed so that the front position, tail, side marker lamps and number plate lights can only be switched on and off simultaneously.
<b>Switch-on control</b> ECE-R48 § 6.13.8	Permitted. If a control device is used, its function must be fulfilled by the control device prescribed for the front position and vehicle position lamps.
<b>Other regulations</b> ECE-R48 § 6.13.9	The front white and the red end-outline marker light may be combined in one lamp, provided that the installation regulations and viewing angle ranges are complied with. Distance between end-outline marker lamp and front position lamp min. 200 mm.

**ECE-R7 § 6.1.1**  
Category A, AM = light intensity min. 4 cd, single lamp max. 140 cd, type "D" lamp max. 70 cd

# APPENDIX

## PLUG-IN DIAGRAM PICTOGRAM OVERVIEW

Always good to know! Which connections does which lamp have?  
What is the meaning of the pictograms used? This information can  
be found on the following pages.

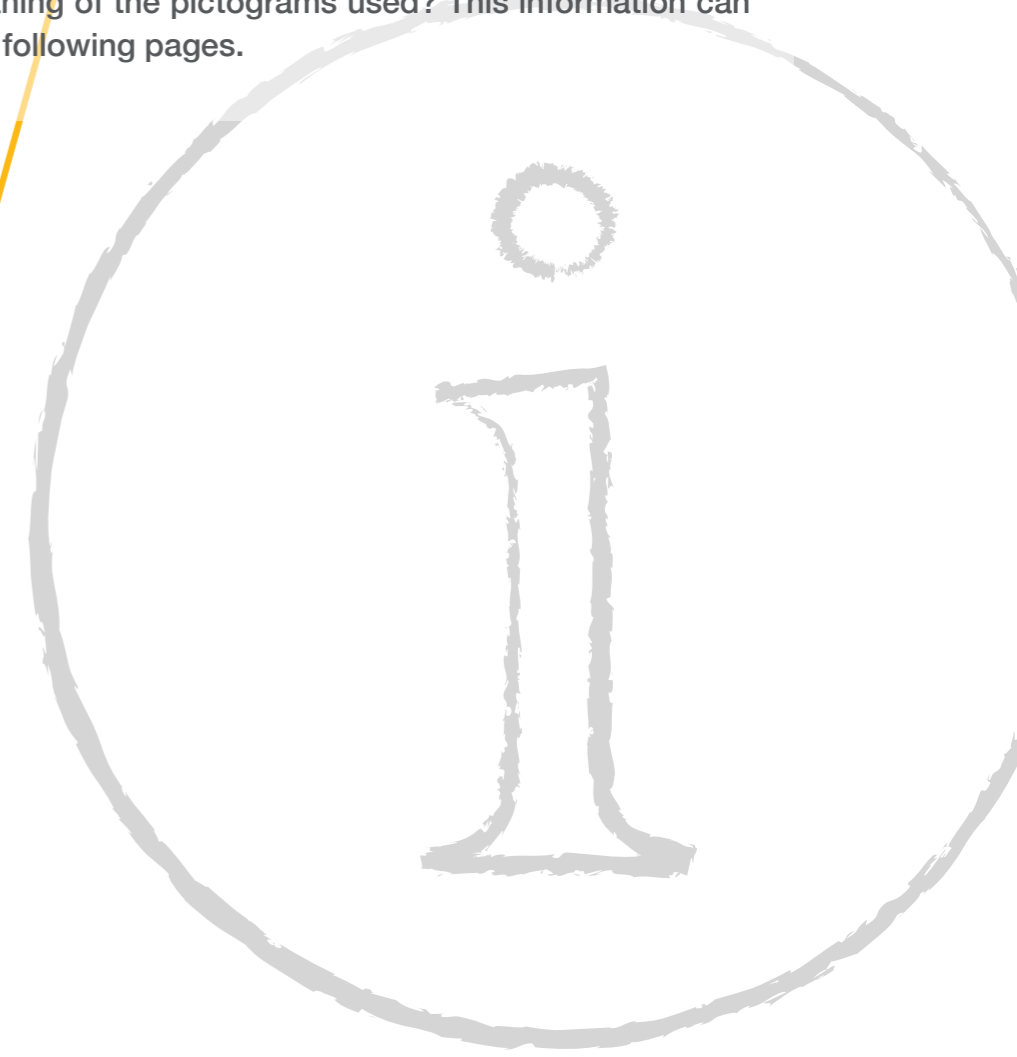

NUMBER PLATE LIGHTS  
ROTATING BEACONS  
PLUG-IN DIAGRAM  
**WORK LAMPS**  
NUMBER PLATE HOLDERS  
SIDE MARKER LAMPS  
REVERSING LIGHTS  
E LIGHT  
NAVIGATION LIGHTS  
**OUTLINE MARKER LAMPS**  
REAR LAMPS  
NUMBER PLATE LIGHTS  
G BEACONS  
**ERIOR LIGHTS**  
LAMPS  
NUMBER PLATE HOLDERS

# PLUG-IN DIAGRAM

Standard plug-in diagram for contact assignment

Contact assignment	Colour (Deviation possible due to different cable types)	DIN NO.	17-pin ASS3	15-pin ISO 12098	Bayonet connector 15-pin	Distributor ASS1	7-pin ISO 1185	Bayonet connector 7-pin GREY	ASS1/2 7-pin BLACK	7-pin ISO 3731	Bayonet connector 7-pin white	ASS1/2 7-pin white
Electrical circuit function												
Blinker left	YL	L	1		1			3				-
Blinker right	GN	R	2		2			5				-
Rear fog light	BL	"S"54g	3		3			-			7	
Ground	WH	31	4		4			1				-
Tail light left	BL	58L	5		5			2				-
Tail light right	BR	58R	6		6			6				-
Stop light	RD	54	7		7			4				-
Reversing light	GR	"S"L	8		8			-			3	
General power supply (+)	BR/BL	"S"54	9		9			-			4	
Wear display	BR/RD	-	10		10			-				-
Spring-loaded display	YL/BL	54g	11		11			7				-
Axle lift	RS	"S"58R	12		12			-			6	
Ground for electronic control units	WH/BL	"S"31	13		13			-			1	
Data cable	VI	"S"58L	14		14			-			2	
Data cable	OR	"S"R	15		15			-			5	
Free	VI/GN	-	16		-			-				-
Free	OR/BL	-	17		-			-				-
Live	Various	-	-		-			-				-

Contact assignment	Colour (Deviation possible due to different cable types)	DIN NO.	Bayonet connector 8-pin BL	ASS1/2 7-pin YL, GN	Bayonet connector 5-pin BLACK		Bayonet connector 2-pin BL, YL, GN	ASS1/2 2-pin BL, YL, GN	ISO 12098 13-pin 24V	ISO 1724 7-pin	ISO 11446 13-pin 12V	ASS3 3-pin
					Bayonet connector 5-pin YELLOW (left)	Bayonet connector 5-pin GREEN (right)						
Electrical circuit function												
Blinker left	YL	L	1		BL	-			3	1	1	-
Blinker right	GN	R	4		-	BL			5	4	4	-
Rear fog light	BL	"S"54g	2		S	-			9	(2)	2	-
Ground	WH	31	3		31	31			1	3	3	1
Tail light left	BL	58L	7		UR	-			2	7	7	-
Tail light right	BR	58R	5		-	UR			6	5	5	-
Stop light	RD	54	6		BR	BR			4	6	6	-
Reversing light	GR	"S"L	8		-	S			8	-	8	-
General power supply (+)	BR/BL	"S"54	-		-	-			10	-	9	-
Wear display	BR/RD	-	-		-	-			-	-	10	-
Spring-loaded display	YL/BL	54g	-		-	-			7	(2)	*	-
Axle lift	RS	"S"58R	-		-	-			13	-	-	-
Ground for electronic control units	WH/BL	"S"31	-		-	-			-	-	13	-
Data cable	VI	"S"58L	-		-	-			11	-	-	-
Data cable	OR	"S"R	-		-	-			12	-	-	-
Free	VI/GN	-	-		-	-			-	-	-	-
Free	OR/BL	-	-		-	-			-	-	-	-
Live	Various	-	-		-	-			2	-	-	2/3

NOTES

# PICTOGRAM OVERVIEW

	Packaging unit
	Left
	Right
	Illuminant
	Volt
	Light bulb
	LED
	Directional indicator
	Directional indicator right
	Directional indicator left
	Dynamic directional indicator, right
	Dynamic directional indicator, left
	SMCG (control of flashing side marker lamps)
	With integrated flashing LCG
	Rear light
	Stop light
	Rear fog lamp
	Reversing light
	Triangular reflector
	Navigation light
	Side marker lamp
	Without side marker lamp
	Front position lamp rear
	Front position lamp

	Red, white, orange
	Black, white, orange
	End-outline marker lamp
	Retro-reflector red
	Retro-reflector white
	Number plate light
	Male
	Female
	Trailer version
	Truck version
	Horizontal mounting
	Vertical mounting
	360° mounting possible
	ADR zone 2
	IP xx protection class
	ISO pulse

# THE ART OF LIGHTS

Aspöck Systems GmbH

Enzing 4 | 4722 Peuerbach | AUSTRIA

Tel.: +43 72 76 / 26 70-0

E-mail: office@aspoeck.com | www.aspoeck.com



## GREAT BRITAIN, IRELAND

### Aspöck UK Ltd.

Unit 19, Stansted Distribution Centre  
Great Hallingbury  
Bishops Stortford, Herts  
GB-CM22 7DG  
Tel.: +44 1279 655 220  
Fax: +44 1279 505 869  
E-mail: sales@aspoeck.co.uk  
www.aspoeck.co.uk

## BRAZIL

### Aspöck do Brasil Ltda.

Estrada RS 122 km 88,5 S/N  
Bairro São Gotardo  
Flores da Cunha-RS  
CEP 95270-000  
Tel.: +55 54 3039-5400  
E-mail: contato@aspock.com.br

## AUSTRIA, HUNGARY, CROATIA, CZECH REPUBLIC

### Ing. A. F. Baeder Ges.m.b.H.

Kolpingstraße 13  
A-1230 Vienna  
Tel.: +43 1 865 16 40  
Fax: +43 1 869 22 12  
E-mail: sales@baeder-automotive.com

## MONTENEGRO, SLOVENIA, BOSNIA AND HERZEGOVINA

### Ing. A. F. Baeder Ges.m.b.H.

Kolpingstraße 13  
A-1230 Vienna  
Tel.: +43 1 865 16 40  
Fax: +43 1 869 22 12  
E-mail: sales@baeder-automotive.com

## USA

### Aspöck UK Ltd.

Unit 19, Stansted Distribution Centre  
Great Hallingbury  
Bishops Stortford, Herts  
CM22 7DG  
Tel.: +44 1279 655 220  
E-mail: sales@aspoeck.co.uk

## FRANCE, LUXEMBOURG ALGERIA, MOROCCO, TUNISIA

### Aspöck France S.A.S.

ZAC Bel Air  
260 Rue des Vergers  
F-69480 Pommiers  
Tel.: +33 437 5508 65  
Fax: +33 437 5508 97  
E-mail: office@aspoeck.fr

## POLAND, LITHUANIA, LATVIA, UKRAINE

### Aspöck Systems Polska Sp.z.o.o.

ul. Byczyńska 10  
46-320 Praszka  
Tel.: +48 34 3430 600  
Fax: +48 34 3430 609  
E-mail: office.poland@aspoeck.com

## AUSTRIA (12V ONLY)

### Knott Handelsges.m.b.H.

Rennweg 79-81  
A-1030 Vienna  
Tel.: +43 1 714 22 22  
Fax: +43 1 714 22 33  
E-mail: info@knott.at

## ISRAEL

### M.N. Systems

Pier St., Industrial Park Emek 10  
Hefer, IL-3877701  
P.O.B 12186  
Tel.: +97 24 6220 111  
Fax: +97 24 6220 808  
E-mail: info@mnsys.co.il

## SPAIN, PORTUGAL

### Aspöck Iberica

Via Sergia, 32 Nave N° 2  
Poligono Industrial  
"Les Hortes del Camí Ral"  
E-08302 Mataró (Barcelona)  
Tel.: +34 937 598 039  
Fax: +34 937 501 033  
E-mail: aspock@aspock.com  
www.aspock.com

## TURKEY, MIDDLE EAST

### Aspöck Aydınlatma Sistemleri Tic. Ltd.

Feneryolu Mah. Yıldırım Sok.  
No 20/B P.K: 34724  
Kadıköy / İstanbul  
Turkey  
Tel.: +90 (0) 216 5105400-3 lines

## SWITZERLAND

### Südo AG für Lastwagenzubehör

Müslistrasse 43  
CH-8957 Spreitenbach  
Tel.: +41 41 348 04 80  
Fax: +41 41 340 31 79  
E-mail: info@agl.ch

## EAST ASIA

### JM Company

312-15, Jaedurumi-gil  
Paju-si, Gyeonggi-do  
10863, S. Korea  
Tel.: +82 31 944 7670  
Fax: +82 31 947 7671

## SWEDEN, FINLAND, NORWAY, DEN- MARK, ESTONIA

### Aspöck Norden AB

Honungsgatan 4  
SE-432 48 Varberg  
Tel.: +46 340 483 870  
E-mail: info@aspoeck-norden.se

## GERMANY

### Suer GmbH & Co KG

Handelsstraße 5  
D-42929 Wermelskirchen  
Tel.: +49 2196 946 0  
Fax: +49 2196 946 100  
E-mail: info@suer.de

## NETHERLANDS, BELGIUM

### Frits Dijk International

Collse Heide 64  
NL-5674 VN Nuenen  
Tel.: +31 40 2831815  
Fax: +31 40 2838717  
E-mail: info@fritsdijk.nl

## RUSSIA, KYRGYZSTAN, MONGOLIA, BELARUS, KAZAKHSTAN

### STAT Ltd

RUS, 125464, Moscow region,  
Volokolamskoe Highway  
House 142  
Pom. I, Room 35, Office 535  
Tel.: +7 (495) 739-03-47  
E-mail: info@stat-parts.ru  
www.stat-parts.ru

## USA

### Aspöck UK Ltd.

Unit 19, Stansted Distribution Centre  
Great Hallingbury  
Bishops Stortford, Herts  
CM22 7DG  
Tel.: +44 1279 655 220  
E-mail: sales@aspoeck.co.uk

## ITALY

### PAGG Aspöck srl

Via Legnano, 8  
I-20835 Muggiò (MB)  
Tel.: +39 039 278 5255  
Fax: +39 039 278 9582  
E-mail: info@aspoeck.it

## GERMANY

### Hofmeister & Meincke

Carsten-Dressler-Straße 6  
D-28279 Bremen  
Tel.: +49 421 8405 296  
Fax: +49 421 8405 201  
E-mail: bremen@hofmei.de

## SERBIA, ROMANIA, BULGARIA, SLOVAKIA

### Ing. A. F. Baeder Ges.m.b.H.

Kolpingstraße 13  
A-1230 Vienna  
Tel.: +43 1 865 16 40  
Fax: +43 1 869 22 12  
E-mail: sales@baeder-automotive.com

## SOUTH AFRICA, BOTSWANA,

## LESOTHO, NAMIBIA, ZIMBABWE, SWAZILAND

### Trail-Link South Africa

699 Seccull Avenue  
0084 Mayville, Pretoria  
P.O.B. 880  
Tel.: +27 12 335 7402  
E-mail: sales@trail-link.co.za