

PCB to PCB Connector for IP66 Stripes

ARTICLE NO. 15-5280-537

Connector with IP 65 protection

PRODUCT FEATURES

- Shell: Polycarbonate
- Application for LED-Stripes with 8mm Width
- For LED-Stripes with a thickness of 0.25 – 0.35mm

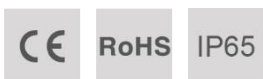

INFORMATIVE DATA

Rated Current	5 A
Rated Voltage	0-36 V
Working Temperature	-20 °C~50 °C
Temperature Resistance (Shell)	105 °C
Flame Rating	UL-94-V0
LEDs per Meter	30 - 120

CONNECTING PCB WITH PCB



Cut the LED-Stripes at the soldering points

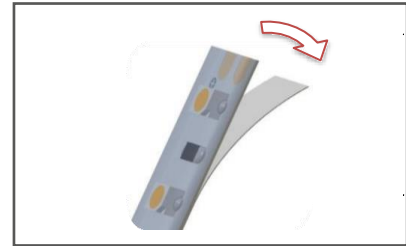

Peel off the 3M tape

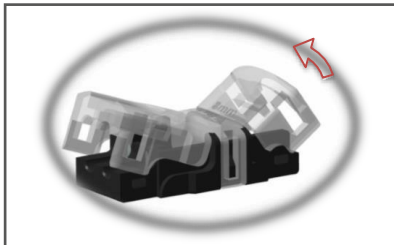

Open the Clear cover of the connector

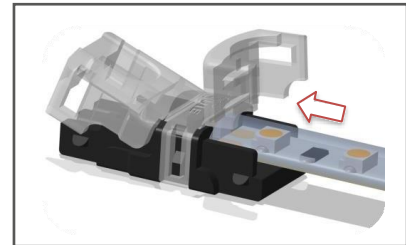

Insert the LED-Stripe

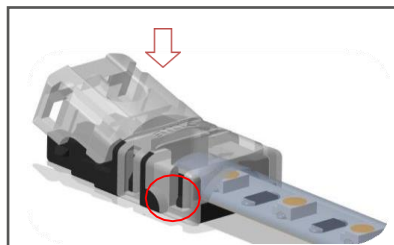

Press the cover down until the lock system is closed

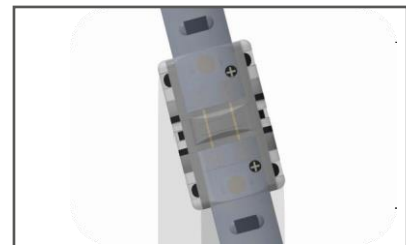

Please take care about the correct polarity

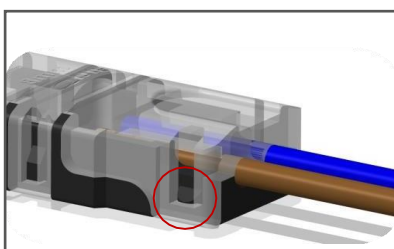

You will hear a “click sound” after you press the cover into the locking

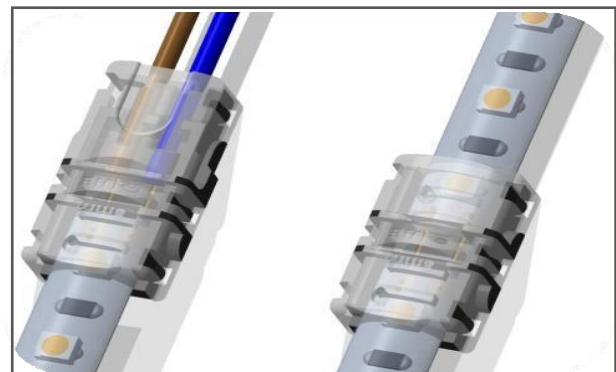

PRODUCT DRAWING

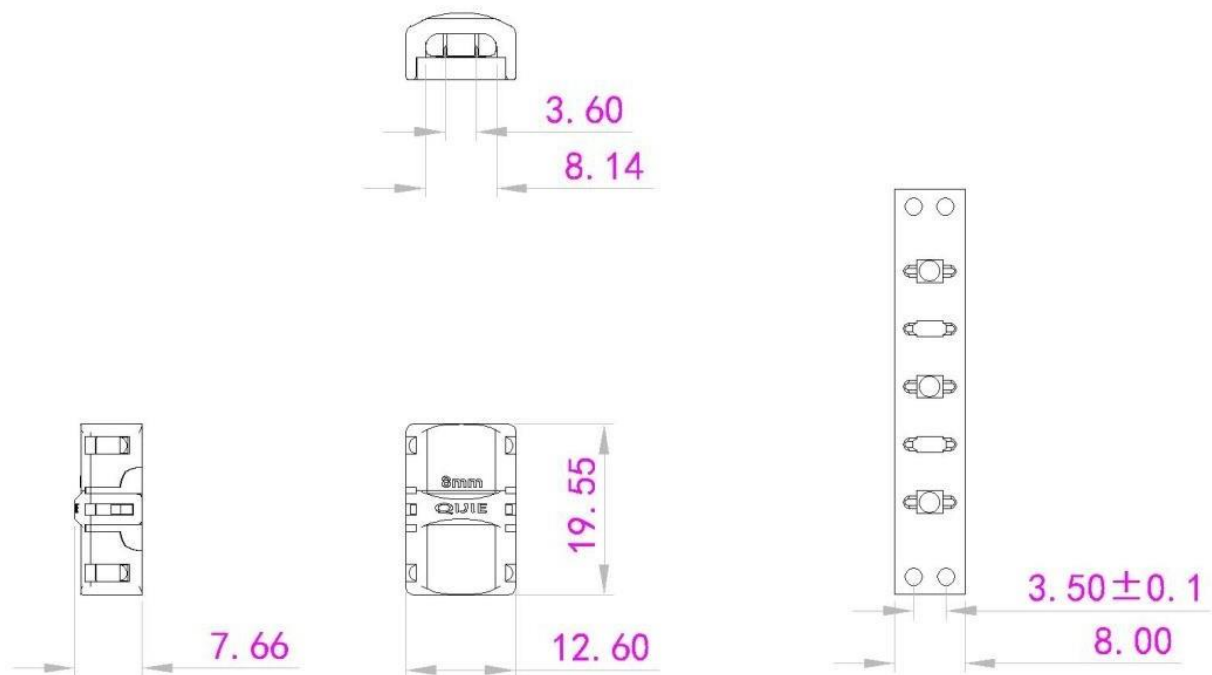

These data can have a tolerance value of +/- 15%. Typing and printing errors reserved.